



The Global Language of Business

GS1 System

Factur-X/ZUGFeRD 2.0

XML Leitfaden für die Schweiz



Informationen zu diesem Dokument

| Dokument | Status |
|------------------|----------------------------------|
| Titel | Factur-X/ZUGFeRD 2.0, GS1 System |
| Letzte Änderung | Juni 2018 |
| Ausgabe | 1 |
| Version | 0 |
| Status | Genemigt |
| Kurzbeschreibung | XML Leitfaden für die Schweiz |

Nachstehende Personen haben zu diesem Dokument beigetragen

| Name | Vorname | Organisation |
|-----------|--------------|---------------------------------|
| Burger | Kilian | Fenaco |
| Chresta | Richard | GS1 Schweiz |
| Ducceschi | Marcel | Migros Genossenschaftsbund |
| Enache | Daniel | Novartis |
| Guillet | Nicolas | Abacus Research AG |
| Leibacher | Markus | Migros Genossenschaftsbund |
| Müller | Daniel | GS1 Schweiz |
| Müller | Rita | MARKANT Syntrade Schweiz AG |
| Richter | Sarah-Louise | Fachhochschule Nordwestschweiz |
| Sporing | Simone | Coop Genossenschaft |
| Tanner | Christian | Fachhochschule Nordwestschweiz |
| Weibel | Roland | GS1 Schweiz |
| Zbinden | Simon | Eidgenössische Finanzverwaltung |

Versionsänderungen

| Version | Datum | Ersteller | Zusammenfassung der Änderungen |
|---------|-----------|-------------|--------------------------------|
| 1.0 | Juli 2018 | GS1 Schweiz | Publikation |

Widerruf (Disclaimer)

Trotz aller Bemühungen, die Korrektheit der im vorliegenden Dokument enthaltenen GS1 Standards sicherzustellen, übernimmt GS1 und jede weitere Partei, die an der Erstellung dieses Dokumentes beteiligt war, keine Gewähr (weder ausdrücklich, noch implizit). Jede Haftung für unmittelbare, mittelbare oder sonstige Schäden oder Verluste, die in Verbindung mit der Verwendung dieses Dokumentes stehen oder aus der Anwendung dieses Dokumentes resultieren, unabhängig von der Klagsache, inklusive Richtigkeit, Gebrauchstauglichkeit oder Zweckmässigkeit, aber nicht darauf beschränkt, wird ausgeschlossen.

Das Dokument kann von Zeit zu Zeit überarbeitet werden, sei es auf Grund von technologischen Entwicklungen, Änderungen in den Standards oder neuen rechtlichen Gegebenheiten. Einige Produkte und Firmennamen, die hier erwähnt werden, können eingetragene Warenzeichen und/oder eingetragene Warenzeichen ihrer jeweiligen Firmen sein. GS1 ist ein eingetragenes Warenzeichen von GS1 AISBL.

Über dieses Dokument

Diese Empfehlung beschreibt die Adaption von FACTUR-X/ZUGFeRD 2.0. Diese kombiniert die CrossIndustryInvoice von UNECE und den ISO Standard 16 PDF/A-3 zu einem hybriden Rechnungsformat. Das vorliegende Dokument bildet die Anforderungen der europäischen Norm EN16931 konform durch ein hybrides Format ab. Bei der Empfehlung für den Schweizer Markt handelt es sich dabei um eine Teilmenge.

Die Grundlagen für diese Empfehlung wurde in einer Arbeitsgruppe, unter Leitung der GS1, erstellt.

Folgende swissDIGIN Felder können in der Empfehlung nicht abgebildet werden:

1. Kostenzuordnungsinformationen (K-06-01)
2. Verweis auf Beilage (K-06-02)
3. Zu- und Abschläge innerhalb der Rechnungsposition (P-03-01 bis P-03-06)
4. Erfüllungsreferenz auf Positionsebene (K-05-02)
5. Start- und Enddatum der Leistungserstellung auf Positionsebene (P-05-01a + P-05-01b)
6. Kostenzuordnungsinformation auf Positionsebene (P-06-01)
7. Verweis auf Beilage auf Positionsebene (P-06-02)
8. Freitext für Inhalt auf Positionsebene (P-06-03)
9. Name Organisationseinheit auf Positionsebene (P-06-04)
10. Rundungsdifferenz (F-02-03)
11. Vorauszahlungsbetrag (F-02-04)
12. Zu bezahlender Rechnungsgesamtbetrag (Rechnungstotal – Vorauszahlung) (F-02-05)

Datentypen:

string = Zeichenkette, kann Sonderzeichen enthalten (CR, LF, TAB)

token = Zeichenkette, Sonderzeichen (CR, LF, TAB), sowie Leerzeichen am Anfang und Ende werden gefiltert

boolean = Schalter mit den Werten richtig/falsch, resp. 1/0

dateTime = Kombinationen aus Datum und evtl. Tageszeit

decimal = Dezimalzahl beliebiger Genauigkeit

Wiederholbarkeit:

1..1 = Das entsprechende Element muss 1x gefüllt werden

1..n = Das entsprechende Element muss mindestens 1x gefüllt werden

0..n = Das entsprechende Element muss nicht, kann aber gefüllt werden

Status:

R = Required – Element muss gefüllt werden

O = Optional - Element kann gefüllt werden

D = Depending – Element muss unter gewissen Umständen gefüllt werden

A = Advised - Befüllung des Feldes empfohlen

Structure

| Occurrence | Element/Attribute |
|------------|-------------------|
|------------|-------------------|

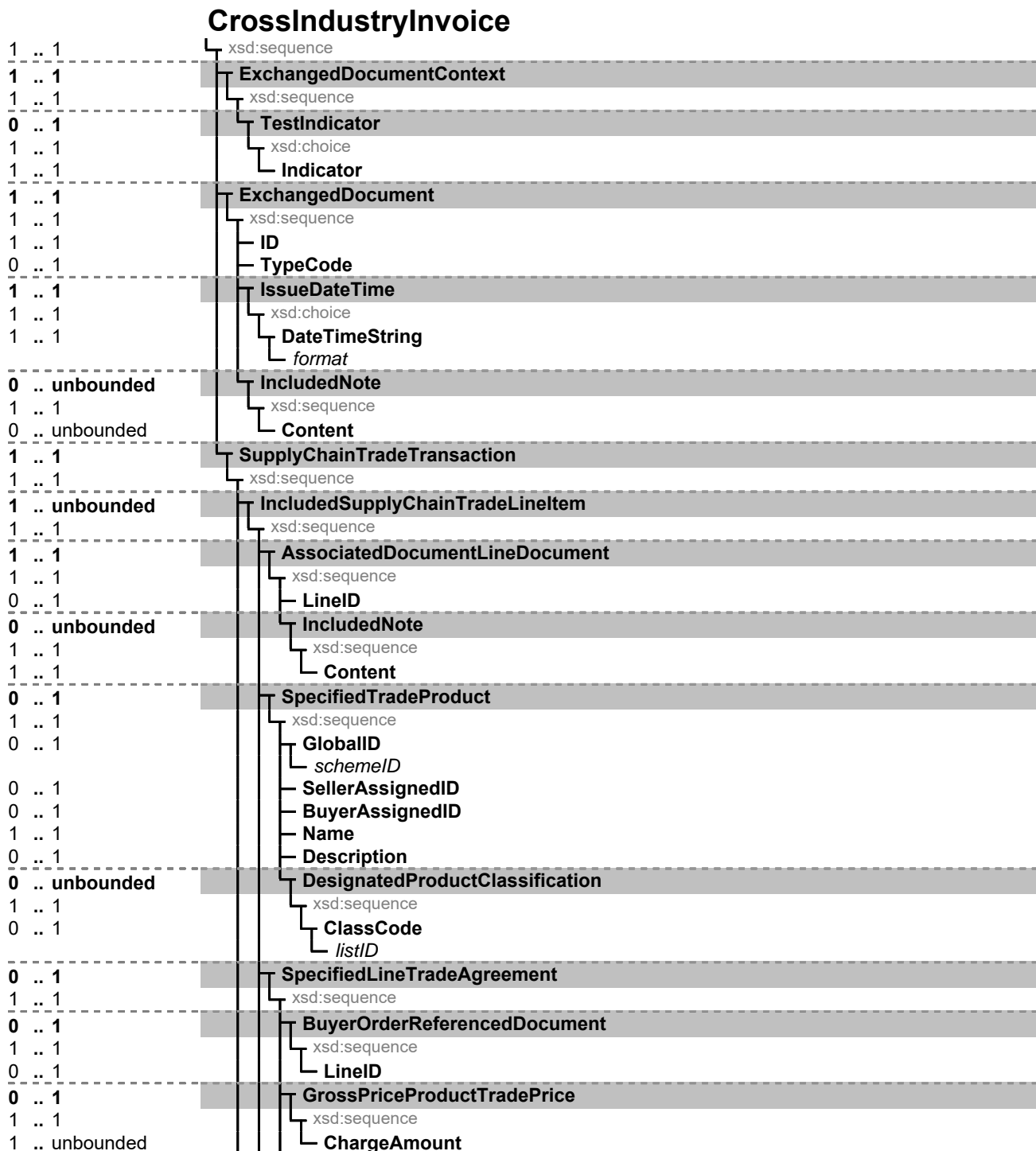

Bold = Simple Element, Bold on grey background = Complex Element, Italic = Attribute, Grey = Group

| Occurrence | Element/Attribute |
|-----------------------|--|
| 0 .. 1 | NetPriceProductTradePrice |
| 1 .. 1 | xsd:sequence |
| 1 .. unbounded | ChargeAmount |
| 0 .. 1 | BasisQuantity |
| | <i>unitCode</i> |
| 0 .. 1 | SpecifiedLineTradeDelivery |
| 1 .. 1 | xsd:sequence |
| 1 .. 1 | BilledQuantity |
| | <i>unitCode</i> |
| 1 .. 1 | SpecifiedLineTradeSettlement |
| 1 .. 1 | xsd:sequence |
| 0 .. unbounded | ApplicableTradeTax |
| 1 .. 1 | xsd:sequence |
| 1 .. 1 | TypeCode |
| 1 .. 1 | RateApplicablePercent |
| 0 .. 1 | SpecifiedTradeSettlementLineMonetarySummation |
| 1 .. 1 | xsd:sequence |
| 1 .. 1 | LineTotalAmount |
| 1 .. 1 | ApplicableHeaderTradeAgreement |
| 1 .. 1 | xsd:sequence |
| 1 .. 1 | BuyerReference |
| 1 .. 1 | SellerTradeParty |
| 1 .. 1 | xsd:sequence |
| 0 .. unbounded | ID |
| 0 .. unbounded | GlobalID |
| | <i>schemeID</i> |
| 1 .. 1 | Name |
| 0 .. unbounded | DefinedTradeContact |
| 1 .. 1 | xsd:sequence |
| 0 .. 1 | PersonName |
| 0 .. 1 | DepartmentName |
| 0 .. 1 | TelephoneUniversalCommunication |
| 1 .. 1 | xsd:sequence |
| 0 .. 1 | CompleteNumber |
| 0 .. 1 | EmailURIUniversalCommunication |
| 1 .. 1 | xsd:sequence |
| 0 .. 1 | URIID |
| 1 .. 1 | PostalTradeAddress |
| 1 .. 1 | xsd:sequence |
| 1 .. 1 | PostcodeCode |
| 1 .. 1 | LineOne |
| 0 .. 1 | LineTwo |
| 0 .. 1 | LineThree |
| 1 .. 1 | CityName |
| 0 .. 1 | CountryID |
| 1 .. 1 | SpecifiedTaxRegistration |
| 1 .. 1 | xsd:sequence |
| 1 .. 1 | ID |
| | <i>schemeID</i> |
| 1 .. 1 | BuyerTradeParty |
| 1 .. 1 | xsd:sequence |

Bold = Simple Element, Bold on grey background = Complex Element, Italic = Attribute, Grey = Group

| Occurrence | Element/Attribute |
|-----------------------|--|
| 0 .. unbounded | ID |
| 0 .. unbounded | GlobalID |
| | <i>schemeID</i> |
| 1 .. 1 | Name |
| 0 .. unbounded | DefinedTradeContact |
| | xsd:sequence |
| 1 .. 1 | PersonName |
| 0 .. 1 | DepartmentName |
| 0 .. 1 | TelephoneUniversalCommunication |
| | xsd:sequence |
| 0 .. 1 | CompleteNumber |
| 0 .. 1 | EmailURIUniversalCommunication |
| | xsd:sequence |
| 0 .. 1 | URIID |
| 1 .. 1 | PostalTradeAddress |
| | xsd:sequence |
| 1 .. 1 | PostcodeCode |
| 1 .. 1 | LineOne |
| 0 .. 1 | LineTwo |
| 0 .. 1 | LineThree |
| 1 .. 1 | CityName |
| 0 .. 1 | CountryID |
| 1 .. 1 | SpecifiedTaxRegistration |
| | xsd:sequence |
| 1 .. 1 | ID |
| | <i>schemeID</i> |
| 0 .. 1 | BuyerOrderReferencedDocument |
| | xsd:sequence |
| 1 .. 1 | IssuerAssignedID |
| 0 .. 1 | ContractReferencedDocument |
| | xsd:sequence |
| 1 .. 1 | IssuerAssignedID |
| 0 .. unbounded | AdditionalReferencedDocument |
| | xsd:sequence |
| 1 .. 1 | IssuerAssignedID |
| 0 .. 1 | TypeCode |
| 1 .. 1 | ApplicableHeaderTradeDelivery |
| | xsd:sequence |
| 0 .. 1 | ShipToTradeParty |
| | xsd:sequence |
| 1 .. 1 | ID |
| 0 .. unbounded | GlobalID |
| 0 .. unbounded | <i>schemeID</i> |
| 1 .. 1 | Name |
| 0 .. 1 | PostalTradeAddress |
| | xsd:sequence |
| 1 .. 1 | PostcodeCode |
| 1 .. 1 | LineOne |
| 0 .. 1 | LineTwo |
| 0 .. 1 | LineThree |
| 1 .. 1 | CityName |

Bold = Simple Element, Bold on grey background = Complex Element, Italic = Attribute, Grey = Group

| Occurrence | Element/Attribute |
|-----------------------|---|
| 0 .. 1 | CountryID |
| 0 .. 1 | ActualDeliverySupplyChainEvent |
| 1 .. 1 | xsd:sequence |
| 1 .. 1 | OccurrenceDateTime |
| 1 .. 1 | xsd:choice |
| 1 .. 1 | DateTimeString |
| | format |
| 1 .. 1 | ApplicableHeaderTradeSettlement |
| 1 .. 1 | xsd:sequence |
| 0 .. unbounded | PaymentReference |
| 1 .. 1 | InvoiceCurrencyCode |
| 0 .. unbounded | SpecifiedTradeSettlementPaymentMeans |
| 1 .. 1 | xsd:sequence |
| 1 .. 1 | PayeePartyCreditorFinancialAccount |
| 1 .. 1 | xsd:sequence |
| 1 .. 1 | IBANID |
| 0 .. 1 | AccountName |
| 0 .. 1 | ProprietaryID |
| 0 .. 1 | PayeeSpecifiedCreditorFinancialInstitution |
| 1 .. 1 | xsd:sequence |
| 0 .. 1 | BICID |
| 0 .. unbounded | ApplicableTradeTax |
| 1 .. 1 | xsd:sequence |
| 1 .. 1 | CalculatedAmount |
| 1 .. 1 | TypeCode |
| 0 .. 1 | ExemptionReason |
| 1 .. 1 | BasisAmount |
| 1 .. 1 | RateApplicablePercent |
| 0 .. 1 | BillingSpecifiedPeriod |
| 1 .. 1 | xsd:sequence |
| 1 .. 1 | StartDateTime |
| 1 .. 1 | xsd:choice |
| 1 .. 1 | DateTimeString |
| | format |
| 1 .. 1 | EndDateTime |
| 1 .. 1 | xsd:choice |
| 1 .. 1 | DateTimeString |
| | format |
| 0 .. unbounded | SpecifiedTradeAllowanceCharge |
| 1 .. 1 | xsd:sequence |
| 1 .. 1 | ChargeIndicator |
| 1 .. 1 | xsd:choice |
| 1 .. 1 | Indicator |
| 0 .. 1 | CalculationPercent |
| 1 .. 1 | BasisAmount |
| 1 .. 1 | ActualAmount |
| 0 .. 1 | ReasonCode |
| 0 .. 1 | Reason |
| 0 .. unbounded | CategoryTradeTax |
| 1 .. 1 | xsd:sequence |
| 1 .. 1 | TypeCode |

Bold = Simple Element, Bold on grey background = Complex Element, Italic = Attribute, Grey = Group

| Occurrence | Element/Attribute |
|-----------------------|--|
| 1 .. 1 | RateApplicablePercent |
| 0 .. unbounded | SpecifiedTradePaymentTerms |
| 1 .. 1 | xsd:sequence |
| 0 .. unbounded | Description |
| 1 .. 1 | DueDateDateTime |
| 1 .. 1 | xsd:choice |
| 1 .. 1 | DateTimeString |
| | <i>format</i> |
| 1 .. 1 | SpecifiedTradeSettlementHeaderMonetarySummation |
| 1 .. 1 | xsd:sequence |
| 1 .. 1 | LineTotalAmount |
| 0 .. unbounded | ChargeTotalAmount |
| 0 .. unbounded | AllowanceTotalAmount |
| 1 .. 1 | TaxBasisTotalAmount |
| 1 .. 1 | TaxTotalAmount |
| | <i>currencyID</i> |
| 0 .. unbounded | RoundingAmount |
| 1 .. 1 | GrandTotalAmount |
| 0 .. unbounded | TotalPrepaidAmount |
| 0 .. unbounded | DuePayableAmount |
| 0 .. 1 | InvoiceReferencedDocument |
| 1 .. 1 | xsd:sequence |
| 0 .. 1 | IssuerAssignedID |
| 0 .. unbounded | ReceivableSpecifiedTradeAccountingAccount |
| 1 .. 1 | xsd:sequence |
| 1 .. 1 | ID |

Bold = Simple Element, Bold on grey background = Complex Element, Italic = Attribute, Grey = Group

Guideline

| Element/Attribute | Annotation |
|-------------------|------------|
|-------------------|------------|

| | |
|---|---|
| CrossIndustryInvoice | <p>Inhalt Rechnung Eine ZUGFeRD-Rechnung muss unabhängig vom Belegbild eine vollständige, eigenständige Rechnung abbilden. Sie soll den gleichen fachlichen Inhalt widerspiegeln, wie das Belegbild.</p> |
| <ul style="list-style-type: none"> xsd:sequence ExchangedDocumentContext | <p>Wiederholbar 1 .. 1</p> <p>Wiederholbar 1 .. 1</p> <p>Inhalt Gruppierung der Eigenschaften der Nachricht</p> |
| <ul style="list-style-type: none"> xsd:sequence TestIndicator | <p>Wiederholbar 1 .. 1</p> <p>Wiederholbar 0 .. 1</p> <p>Inhalt Testkennzeichen Das Testkennzeichen kann bei der Einführung eines neuen Systems verwendet werden, um die Rechnung als "Testrechnung" zu kennzeichnen.</p> |
| <ul style="list-style-type: none"> xsd:choice Indicator | <p>Wiederholbar 1 .. 1</p> <p>Wiederholbar 1 .. 1</p> <p>Typ boolean</p> |
| ExchangedDocument | <p>Wiederholbar 1 .. 1</p> <p>Inhalt Gruppierung der Eigenschaften, die das gesamte Dokument betreffen.</p> |
| <ul style="list-style-type: none"> xsd:sequence ID | <p>Wiederholbar 1 .. 1</p> <p>Wiederholbar 1 .. 1</p> <p>swissDIGIN K-01-02</p> <p>Typ token</p> <p>Inhalt Rechnungsnummer</p> |
| TypeCode | <p>Wiederholbar 0 .. 1</p> <p>swissDIGIN K-01-01</p> <p>Typ token</p> <p>Inhalt Dokumentenart (Code)</p> <p style="background-color: #cccccc;">Zugelassene Codes</p> <p>380 Commercial Invoice</p> <p>381 Credit Note</p> <p>Remark: All other codes out of codelist 1001 must be agreed between sender and receiver.</p> |
| IssueDateTime | <p>Wiederholbar 1 .. 1</p> <p>Inhalt Rechnungsdatum</p> |
| <ul style="list-style-type: none"> xsd:choice DateTimeString | <p>Wiederholbar 1 .. 1</p> <p>Wiederholbar 1 .. 1</p> <p>swissDIGIN K-01-03</p> <p>Typ dateTime</p> |
| <ul style="list-style-type: none"> <i>format</i> | <p>Inhalt Datum, Format</p> <p style="background-color: #cccccc;">Zugelassene Codes</p> <p>102 JJJJMMTT</p> |
| IncludedNote | <p>Wiederholbar 0 .. unbounded</p> <p>Inhalt Freitext auf Kopfebene</p> |
| <ul style="list-style-type: none"> xsd:sequence Content | <p>Wiederholbar 1 .. 1</p> <p>Wiederholbar 0 .. unbounded</p> <p>swissDIGIN K-06-03</p> <p>Typ string</p> <p>Inhalt Freitext auf Kopfebene (Textinhalt)</p> |
| SupplyChainTradeTransaction | <p>Wiederholbar 1 .. 1</p> <p>Inhalt Gruppierung der Informationen zum Geschäftsvorfall</p> |
| <ul style="list-style-type: none"> xsd:sequence IncludedSupplyChainTradeLineItem | <p>Wiederholbar 1 .. 1</p> <p>Wiederholbar 1 .. unbounded</p> <p>Inhalt Gruppierung von Positionsangaben</p> |

Bold = Element, Italic = Attribute, Grey = Group

| Element/Attribute | Annotation |
|--|--|
| <i>xsd:sequence</i> | Wiederholbar 1 .. 1 |
| AssociatedDocumentLineDocument | Wiederholbar 1 .. 1 Inhalt Gruppierung von allgemeinen Positionsangaben |
| <i>xsd:sequence</i> | Wiederholbar 1 .. 1 |
| LineID | Wiederholbar 0 .. 1 Typ token Inhalt Positionsnummer |
| IncludedNote | Wiederholbar 0 .. unbounded Inhalt Detailinformationen zur Position |
| <i>xsd:sequence</i> | Wiederholbar 1 .. 1 |
| Content | Wiederholbar 1 .. 1 Typ string Inhalt Freitext zur Position |
| SpecifiedTradeProduct | Wiederholbar 0 .. 1 Inhalt Gruppierung von Angaben zum Produkt bzw. zur erbrachten Leistung |
| <i>xsd:sequence</i> | Wiederholbar 1 .. 1 |
| GlobalID | Wiederholbar 0 .. 1 swissDIGIN P-02-03 Typ token Inhalt Globaler Identifier des Produktes |
| <i>schemeID</i> | Inhalt Art der globalen Artikelnummer |
| SellerAssignedID | Zugelassene Codes ISO 6523 Alle Codes dieser Codeliste sind gültig Wiederholbar 0 .. 1 swissDIGIN P-02-01 Typ token Inhalt Artikelnummer des Verkäufers |
| BuyerAssignedID | Wiederholbar 0 .. 1 swissDIGIN P-02-02 Typ token Inhalt Artikelnummer des Käufers Der Identifier des Produktes ist eine eindeutige, bilateral vereinbarte Kennzeichnung des Produktes. Es kann sich beispielsweise um die Kundenartikelnummer bzw. die vom Hersteller vergebene Artikelnummer handeln. |
| Name | Wiederholbar 1 .. 1 Typ string Inhalt Artikelbezeichnung |
| Description | Wiederholbar 0 .. 1 swissDIGIN P-02-04 Typ string Inhalt Artikelbeschreibung |
| DesignatedProductClassification | Wiederholbar 0 .. unbounded Inhalt Detailinformationen zur Produktklassifikation |
| <i>xsd:sequence</i> | Wiederholbar 1 .. 1 |
| ClassCode | Wiederholbar 0 .. 1 swissDIGIN P-02-03.1 Typ token Inhalt Klassifikation des Produktes (Code) |
| <i>listID</i> | Inhalt Identifikation/Art der Produktklassifikation |
| | Zugelassene Codes BUYER_ASSIG vom Käufer vergeben ECL eCl@ss GPC Global Product Classification (GS1) HS Zolltarifnummer (Harmonised System) SELLER_ASSIG Vom Verkäufer vergeben |

Bold = Element, Italic = Attribute, Grey = Group

| Element/Attribute | Annotation |
|-------------------------------------|--|
| Zugelassene Codes | |
| UNSPSC | United Nations Standard Products and Services Code® (UNSPSC®) |
| SpecifiedLineTradeAgreement | Wiederholbar 0 .. 1 Inhalt Gruppierung der Vertragsangaben auf Positionsebene |
| xsd:sequence | Wiederholbar 1 .. 1 |
| BuyerOrderReferencedDocument | Wiederholbar 0 .. 1 Inhalt Detailangaben zur zugehörigen Bestellung |
| xsd:sequence | Wiederholbar 1 .. 1 |
| LineID | Wiederholbar 0 .. 1 Typ token Inhalt Bestellposition swissDIGIN P-01-02 |
| GrossPriceProductTradePrice | Wiederholbar 0 .. 1 Inhalt Detailinformationen zum Preis gemäss Bruttokalkulation exklusive Umsatzsteuer |
| xsd:sequence | Wiederholbar 1 .. 1 |
| ChargeAmount | Wiederholbar 1 .. unbounded swissDIGIN P-04-02 Typ decimal Inhalt Bruttopreis Wird der Preis gemäß Nettokalkulation ausgewiesen, muss auch der Preis gemäß Bruttokalkulation ausgewiesen werden. |
| NetPriceProductTradePrice | Wiederholbar 0 .. 1 |
| xsd:sequence | Wiederholbar 1 .. 1 |
| ChargeAmount | Wiederholbar 1 .. unbounded swissDIGIN P-04-01 Typ decimal |
| BasisQuantity | Wiederholbar 0 .. 1 Typ decimal swissDIGIN P-02-05 |
| <i>unitCode</i> | swissDIGIN P-02-06 |
| Zugelassene Codes | |
| C62 | Eins (Stück) |
| DAY | Tag(e) |
| HAR | Hektar |
| HUR | Stunde |
| KGM | Kilogramm |
| KTM | Kilometer |
| LS | Pauschale |
| LTR | Liter |
| MIN | Minute |
| MMK | Quadratmillimeter |
| MMT | Millimeter |
| MTK | Quadratmeter |
| MTQ | Kubikmeter |
| MTR | Meter |
| NAR | Anzahl Artikel |
| NPR | Anzahl Paare |
| P1 | Prozent |
| SET | Set(s) |
| TNE | Tonne (metrisch) |
| WEE | Woche(n) |
| SpecifiedLineTradeDelivery | Wiederholbar 0 .. 1 Inhalt Gruppierung von Lieferangaben aus Positionsebene |
| xsd:sequence | Wiederholbar 1 .. 1 |
| BilledQuantity | Wiederholbar 1 .. 1 |

Bold = Element, Italic = Attribute, Grey = Group

| Element/Attribute | Annotation |
|--|--|
| | swissDIGIN P-02-07 Typ decimal Inhalt Menge, berechnet |
| <i>unitCode</i> | Inhalt Masseinheit Zugelassene Codes C62 Eins (Stück) DAY Tag(e) HAR Hektar HUR Stunde KGM Kilogramm KTM Kilometer LS Pauschale LTR Liter MIN Minute MMK Quadratmillimeter MMT Millimeter MTK Quadratmeter MTQ Kubikmeter MTR Meter NAR Anzahl Artikel NPR Anzahl Paare P1 Prozent SET Set(s) TNE Tonne (metrisch) WEE Woche(n) |
| SpecifiedLineTradeSettlement | Wiederholbar 1 .. 1 Inhalt Gruppierung von Angaben zur Abrechnung auf Positionsebene |
| xsd:sequence | Wiederholbar 1 .. 1 |
| ApplicableTradeTax | Wiederholbar 0 .. unbounded Inhalt Detailangaben zu Steuern |
| xsd:sequence | Wiederholbar 1 .. 1 |
| TypeCode | Wiederholbar 1 .. 1 Typ token Inhalt Steuerart (Code) Zugelassene Codes VAT Mehrwertsteuer |
| RateApplicablePercent | Wiederholbar 1 .. 1 swissDIGIN P-04-03 Typ decimal Inhalt Steuerprozentsatz |
| SpecifiedTradeSettlementLineMonetarySummation | Wiederholbar 0 .. 1 Inhalt Detailinformationen zu Positionssummen |
| xsd:sequence | Wiederholbar 1 .. 1 |
| LineTotalAmount | Wiederholbar 1 .. 1 swissDIGIN P-04-04 Typ decimal Inhalt Gesamtpositionsbetrag |
| ApplicableHeaderTradeAgreement | Wiederholbar 1 .. 1 Inhalt Gruppierung der Vertragsangaben |
| xsd:sequence | Wiederholbar 1 .. 1 |
| BuyerReference | Wiederholbar 1 .. 1 swissDIGIN K-01-05 Typ string Inhalt Referenz des Käufers |
| SellerTradeParty | Wiederholbar 1 .. 1 Inhalt Detailinformationen zum Verkäufer (= Leistungserbringer) |

Bold = Element, Italic = Attribute, Grey = Group

| Element/Attribute | Annotation |
|--|---|
| <i>xsd:sequence</i> | Wiederholbar 1 .. 1 |
| ID | Wiederholbar 0 .. unbounded GloablID, falls über @schemeID eine Qualifizierung vorgenommen werden kann, sonst ID swissDIGIN K-02-01 Typ token Inhalt Identifier des Verkäufers |
| GlobalID | Wiederholbar 0 .. unbounded GloablID, falls über @schemeID eine Qualifizierung vorgenommen werden kann, sonst ID swissDIGIN K-02-01 Typ token Inhalt Globaler Identifier des Verkäufers |
| <i>schemeID</i> | Inhalt Art der globalen Identifikationsnummer |
| | Zugelassene Codes |
| | ISO 6523 Alle Codes dieser Codeliste sind gültig |
| Name | Wiederholbar 1 .. 1 swissDIGIN K-02-03-a Typ string Inhalt Firmierung/Name des Verkäufers |
| DefinedTradeContact | Wiederholbar 0 .. unbounded Inhalt Detailinformationen zum Ansprechpartner des Verkäufers |
| <i>xsd:sequence</i> | Wiederholbar 1 .. 1 |
| PersonName | Wiederholbar 0 .. 1 swissDIGIN K-02-05 Typ string Inhalt Ansprechpartnername des Verkäufers |
| DepartmentName | Wiederholbar 0 .. 1 swissDIGIN K-02-04 Typ string Inhalt Abteilungsname des Verkäufers |
| TelephoneUniversalCommunication | Wiederholbar 0 .. 1 Inhalt Detailinformationen zur Telefonnummer des Verkäufers |
| <i>xsd:sequence</i> | Wiederholbar 1 .. 1 |
| CompleteNumber | Wiederholbar 0 .. 1 Typ string Inhalt Telefonnummer des Verkäufers swissDIGIN K-02-05 |
| EmailURIUniversalCommunication | Wiederholbar 0 .. 1 Inhalt Detailinformationen zur Emailadresse des Verkäufers |
| <i>xsd:sequence</i> | Wiederholbar 1 .. 1 |
| URIID | Wiederholbar 0 .. 1 Typ token Inhalt Emailadresse des Verkäufers swissDIGIN K-02-05 |
| PostalTradeAddress | Wiederholbar 1 .. 1 Inhalt Detailinformationen zur Anschrift des Verkäufers |
| <i>xsd:sequence</i> | Wiederholbar 1 .. 1 |
| PostcodeCode | Wiederholbar 1 .. 1 swissDIGIN K-02-03-d Typ token Inhalt Postleitzahl des Verkäufers |
| LineOne | Wiederholbar 1 .. 1 swissDIGIN K-02-03-b Typ string Inhalt Adresszeile 1 des Verkäufers |
| LineTwo | Wiederholbar 0 .. 1 swissDIGIN K-02-03-b |

Bold = Element, *Italic* = Attribute, Grey = Group



| Element/Attribute | Annotation |
|---------------------------------|--|
| LineThree | Typ string Inhalt Adresszeile 2 des Verkäufers Wiederholbar 0 .. 1 swissDIGIN K-02-03-b |
| CityName | Typ string Inhalt Adresszeile 3 des Verkäufers Wiederholbar 1 .. 1 swissDIGIN K-02-03-c |
| CountryID | Typ string Inhalt Ort des Verkäufers Wiederholbar 0 .. 1 swissDIGIN K-02-03-e Typ token Inhalt Land des Verkäufers (Code) Zugelassene Codes ISO 3166-1 alpha-2 Alle Codes dieser Codeliste sind gültig |
| SpecifiedTaxRegistration | Wiederholbar 1 .. 1 Inhalt Detailangaben zu Steuerangaben des Verkäufers |
| <i>xsd:sequence</i> | Wiederholbar 1 .. 1 |
| ID | Wiederholbar 1 .. 1 swissDIGIN K-02-02 Typ token Inhalt Umsatzsteuernummer des Verkäufers |
| <i>schemeID</i> | Inhalt Art der Steuernummer des Verkäufers Zugelassene Codes VA Mehrwertsteuernummer |
| BuyerTradeParty | Wiederholbar 1 .. 1 Inhalt Detailinformationen zum Käufer (=Leistungsempfänger) |
| <i>xsd:sequence</i> | Wiederholbar 1 .. 1 |
| ID | Wiederholbar 0 .. unbounded Inhalt GloablID, falls über @schemeID eine Qualifizierung vorgenommen werden kann, sonst ID swissDIGIN K-03-01 Typ token Inhalt Identifizier des Käufers |
| GlobalID | Wiederholbar 0 .. unbounded Inhalt GloablID, falls über @schemeID eine Qualifizierung vorgenommen werden kann, sonst ID swissDIGIN K-03-01 Typ token Inhalt Globaler Identifizier des Käufers |
| <i>schemeID</i> | Inhalt Art der globalen Identifikationsnummer Zugelassene Codes ISO 6523 Alle Codes dieser Codeliste sind gültig |
| Name | Wiederholbar 1 .. 1 swissDIGIN K-03-03-a Typ string Inhalt Firmierung/Name des Käufers |
| DefinedTradeContact | Wiederholbar 0 .. unbounded Inhalt Detailinformationen zum Ansprechpartner des Käufers |
| <i>xsd:sequence</i> | Wiederholbar 1 .. 1 |
| PersonName | Wiederholbar 0 .. 1 swissDIGIN K-03-06 Typ string Inhalt Ansprechpartnername des Käufers |
| DepartmentName | Wiederholbar 0 .. 1 |

Bold = Element, Italic = Attribute, Grey = Group

| Element/Attribute | Annotation |
|--|---|
| | swissDIGIN K-03-05 |
| | Typ string |
| | Inhalt Abteilungsname des Käufers |
| TelephoneUniversalCommunication | Wiederholbar 0 .. 1 |
| | Inhalt Detailinformationen zur Telefonnummer des Käufers |
| xsd:sequence | Wiederholbar 1 .. 1 |
| CompleteNumber | Wiederholbar 0 .. 1 |
| | Typ string |
| | Inhalt Telefonnummer des Käufers |
| EmailURIUniversalCommunication | Wiederholbar 0 .. 1 |
| | Inhalt Detailinformationen zur Emailadresse des Käufers |
| xsd:sequence | Wiederholbar 1 .. 1 |
| URIID | Wiederholbar 0 .. 1 |
| | Typ token |
| | Inhalt Emailadresse des Käufers |
| PostalTradeAddress | Wiederholbar 1 .. 1 |
| | Inhalt Detailinformationen zur Anschrift des Käufers |
| xsd:sequence | Wiederholbar 1 .. 1 |
| PostcodeCode | Wiederholbar 1 .. 1 |
| | swissDIGIN K-03-03-d |
| | Typ token |
| | Inhalt Postleitzahl des Käufers |
| LineOne | Wiederholbar 1 .. 1 |
| | swissDIGIN K-03-03-b |
| | Typ string |
| | Inhalt Adresszeile 1 des Käufers |
| LineTwo | Wiederholbar 0 .. 1 |
| | swissDIGIN K-03-03-b |
| | Typ string |
| | Inhalt Adresszeile 2 des Käufers |
| LineThree | Wiederholbar 0 .. 1 |
| | swissDIGIN K-03-03-b |
| | Typ string |
| | Inhalt Adresszeile 3 des Käufers |
| CityName | Wiederholbar 1 .. 1 |
| | swissDIGIN K-03-03-c |
| | Typ string |
| | Inhalt Ort des Käufers |
| CountryID | Wiederholbar 0 .. 1 |
| | swissDIGIN K-03-03-e |
| | Typ token |
| | Inhalt Land des Käufers (Code) |
| | Zugelassene Codes |
| | ISO 3166-1 alpha-2 Alle Codes dieser Codeliste sind gültig |
| SpecifiedTaxRegistration | Wiederholbar 1 .. 1 |
| | Inhalt Detailangaben zu Steuerangaben des Käufers |
| xsd:sequence | Wiederholbar 1 .. 1 |
| ID | Wiederholbar 1 .. 1 |
| | swissDIGIN K-03-02 |
| | Typ token |
| | Inhalt Umsatzsteuernummer des Käufers |
| <i>schemaID</i> | Inhalt Art der Steuernummer des Käufers |
| | Zugelassene Codes |
| | VA Mehrwertsteuernummer |
| BuyerOrderReferencedDocument | Wiederholbar 0 .. 1 |
| | Inhalt Detailangaben zur zugehörigen Bestellung |
| | swissDIGIN K-01-06 |

Bold = Element, Italic = Attribute, Grey = Group

| Element/Attribute | Annotation |
|--------------------------------------|---|
| <i>xsd:sequence</i> | Wiederholbar 1 .. 1 |
| IssuerAssignedID | Wiederholbar 1 .. 1 Typ token Inhalt Bestellnummer |
| ContractReferencedDocument | Wiederholbar 0 .. 1 Inhalt Detailangaben zum zugehörigen Vertrag |
| <i>xsd:sequence</i> | Wiederholbar 1 .. 1 |
| IssuerAssignedID | Wiederholbar 1 .. 1 Typ token Inhalt Vertragsnummer swissDIGIN K-01-06 |
| AdditionalReferencedDocument | Wiederholbar 0 .. unbounded Inhalt Detailangaben zu einer zusätzlichen Dokumentenreferenz |
| <i>xsd:sequence</i> | Wiederholbar 1 .. 1 |
| IssuerAssignedID | Wiederholbar 0 .. 1 swissDIGIN K-01-07 swissDIGIN K-04-04 Typ token Inhalt Dokumentennummer |
| TypeCode | Wiederholbar 0 .. 1 Typ token Inhalt Art des referenzierten Dokuments |
| | Zugelassene Codes |
| | 50 Code für "Tender or lot referencd" |
| | 130 Code für "Invoiced object identifier" |
| | 916 Code für "Supporting document reference" |
| ApplicableHeaderTradeDelivery | Wiederholbar 1 .. 1 Inhalt Gruppierung der Lieferangaben |
| <i>xsd:sequence</i> | Wiederholbar 1 .. 1 |
| ShipToTradeParty | Wiederholbar 0 .. 1 Inhalt Detailangaben zum abweichenden Warenempfänger |
| <i>xsd:sequence</i> | Wiederholbar 1 .. 1 |
| ID | Wiederholbar 0 .. unbounded GloablID, falls über @schemeID eine Qualifizierung vorgenommen werden kann, sonst ID swissDIGIN K-04-02-a1 Typ token Inhalt Identifizier des Warenempfängers |
| GlobalID | Wiederholbar 0 .. unbounded GloablID, falls über @schemeID eine Qualifizierung vorgenommen werden kann, sonst ID swissDIGIN K-04-02-a1 Typ token Inhalt Globaler Identifizier des Warenempfängers |
| <i>schemeID</i> | Inhalt Art der globalen Identifikationsnummer |
| | Zugelassene Codes |
| | ISO 6523 Alle Codes dieser Codeliste sind gültig |
| Name | Wiederholbar 1 .. 1 swissDIGIN K-04-02-a Typ string Inhalt Name/Firmierung des Warenempfängers |
| PostalTradeAddress | Wiederholbar 0 .. 1 Inhalt Detailinformationen zur Anschrift des Warenempfängers |
| <i>xsd:sequence</i> | Wiederholbar 1 .. 1 |
| PostcodeCode | Wiederholbar 1 .. 1 swissDIGIN K-04-02-d Typ token Inhalt Postleitzahl des Warenempfängers |

Bold = Element, Italic = Attribute, Grey = Group

| Element/Attribute | Annotation |
|---|---|
| LineOne | Wiederholbar 1 .. 1 swissDIGIN K-04-02-b Typ string Inhalt Adresszeile 1 des Warenempfängers |
| LineTwo | Wiederholbar 0 .. 1 swissDIGIN K-04-02-b Typ string Inhalt Adresszeile 2 des Warenempfängers |
| LineThree | Wiederholbar 0 .. 1 swissDIGIN K-04-02-b Typ string Inhalt Adresszeile 3 des Warenempfängers |
| CityName | Wiederholbar 1 .. 1 swissDIGIN K-04-02-c Typ string Inhalt Ort des Warenempfängers |
| CountryID | Wiederholbar 0 .. 1 swissDIGIN K-04-02-e Typ token Inhalt Land des Warenempfängers Zugelassene Codes ISO 3166-1 alpha-2 Alle Codes dieser Codeliste sind gültig |
| ActualDeliverySupplyChainEvent | Wiederholbar 0 .. 1 Inhalt Detailinformationen zur tatsächlichen Lieferung |
| <i>xsd:sequence</i> | |
| OccurrenceDateTime | Wiederholbar 1 .. 1 Inhalt Tatsächlicher Lieferzeitpunkt |
| <i>xsd:choice</i> | |
| DateTimeString | Wiederholbar 1 .. 1 swissDIGIN K-04-01-a Typ dateTime Zugelassene Codes 102 JJJMMTT 610 JJJJMM 616 JJJJWW |
| <i>format</i> | |
| ApplicableHeaderTradeSettlement | Wiederholbar 1 .. 1 Inhalt Gruppierung von Angaben zur Zahlung |
| <i>xsd:sequence</i> | |
| PaymentReference | Wiederholbar 1 .. 1 Wiederholbar 0 .. unbounded swissDIGIN K-05-05 Typ string Inhalt Zahlungsreferenz |
| InvoiceCurrencyCode | Wiederholbar 1 .. 1 swissDIGIN K-01-04 Typ token Inhalt Währung Zugelassene Codes ISO 4217 3A Alle Codes dieser Codeliste sind gültig |
| SpecifiedTradeSettlementPaymentMeans | Wiederholbar 0 .. unbounded Inhalt Detailinformation zur Zahlungsart |
| <i>xsd:sequence</i> | |
| PayeePartyCreditorFinancialAccount | Wiederholbar 1 .. 1 Wiederholbar 1 .. 1 Inhalt Bankverbindung des Verkäufers |
| <i>xsd:sequence</i> | |
| IBANID | Wiederholbar 1 .. 1 swissDIGIN K-05-08-a Typ token |

Bold = Element, Italic = Attribute, Grey = Group

| Element/Attribute | Annotation |
|---|--|
| AccountName | Inhalt IBAN Wiederholbar 0 .. 1 swissDIGIN K-05-08-b Typ string Inhalt Kontoname Angabe nur erforderlich, falls abweichend vom Namen des Zahlungsempfängers/Verkäufers |
| ProprietaryID | Wiederholbar 0 .. 1 Falls keine IBAN swissDIGIN K-05-06 Typ token Inhalt Kontonummer Wird mit vollendeter SEPA-Einführung hinfällig. Bis dahin kann die Kontonummer übergangsweise angegeben werden. Dies ist nur im nationalen Kontext anwendbar. Die ESR Nummer soll im Format 99-999999-9 eingegeben werden. |
| PayeeSpecifiedCreditorFinancialInstitution | Wiederholbar 0 .. 1 Inhalt Bankinstitut des Verkäufers |
| xsd:sequence | Wiederholbar 1 .. 1 |
| BICID | Wiederholbar 0 .. 1 swissDIGIN K-05-07-a Typ token Inhalt BIC |
| ApplicableTradeTax | Wiederholbar 0 .. unbounded Inhalt Detailinformationen zu Steuerangaben |
| xsd:sequence | Wiederholbar 1 .. 1 |
| CalculatedAmount | Wiederholbar 1 .. 1 swissDIGIN F-01-03 Typ decimal Inhalt Steuerbetrag |
| TypeCode | Wiederholbar 1 .. 1 swissDIGIN K-02-02.1 Typ token Inhalt Steuerart (Code) |
| Zugelassene Codes | |
| ExemptionReason | VAT Mehrwertsteuer Wiederholbar 0 .. 1 swissDIGIN F-01-04 Typ string Inhalt Grund der Steuerbefreiung (Freitext) |
| BasisAmount | Wiederholbar 1 .. 1 swissDIGIN F-01-02 Typ decimal Inhalt Steuerbasisbetrag |
| RateApplicablePercent | Wiederholbar 1 .. 1 swissDIGIN F-01-01 Typ decimal Inhalt Steuerprozentsatz |
| BillingSpecifiedPeriod | Wiederholbar 0 .. 1 Inhalt Detailinformationen zur Rechnungsperiode |
| xsd:sequence | Wiederholbar 1 .. 1 |
| StartDateTime | Wiederholbar 1 .. 1 swissDIGIN K-04-01-b Inhalt Beginn der Rechnungsperiode |
| xsd:choice | Wiederholbar 1 .. 1 |
| DateTimeString | Wiederholbar 1 .. 1 Typ dateTime Inhalt Datum, Format |

Bold = Element, Italic = Attribute, Grey = Group

| Element/Attribute | Annotation |
|--------------------------------------|--|
| | Zugelassene Codes |
| | 102 JJJMMTT |
| | 610 JJJMM |
| | 616 JJJWW |
| <i>format</i> | |
| | Zugelassene Codes |
| | 102 JJJMMTT |
| | 610 JJJMM |
| | 616 JJJWW |
| EndDateTime | Wiederholbar 1 .. 1 |
| | swissDIGIN K-04-01-a |
| | Inhalt Ende der Rechnungsperiode |
| <i>xsd:choice</i> | |
| DateTimeString | Wiederholbar 1 .. 1 |
| | Wiederholbar 1 .. 1 |
| | Typ dateTime |
| <i>format</i> | |
| | Zugelassene Codes |
| | 102 JJJMMTT |
| | 610 JJJMM |
| | 616 JJJWW |
| SpecifiedTradeAllowanceCharge | Wiederholbar 0 .. unbounded |
| | Inhalt Detailinformationen zu Zu- und Abschlägen |
| <i>xsd:sequence</i> | |
| ChargeIndicator | Wiederholbar 1 .. 1 |
| <i>xsd:choice</i> | |
| Indicator | Wiederholbar 1 .. 1 |
| | Wiederholbar 1 .. 1 |
| | Inhalt Schalter für Zu-/Abschlag |
| CalculationPercent | Wiederholbar 0 .. 1 |
| | Typ decimal |
| | Inhalt Zu-/Abschlag in Prozent |
| BasisAmount | Wiederholbar 1 .. 1 |
| | Typ decimal |
| | Inhalt Basisbetrag des Zu-/Abschlags |
| ActualAmount | Wiederholbar 1 .. 1 |
| | Typ decimal |
| | Inhalt Betrag des Zu-/Abschlags |
| ReasonCode | Wiederholbar 0 .. 1 |
| | Typ token |
| | Inhalt Grund des Zu-/Abschlags (Code) |
| | Zugelassene Codes |
| | AA Werbekostenzuschuss |
| | ADR Andere Dienste |
| | AEO Sammel- und Recyclingservice |
| | DI Abzug (Rabatt) |
| | EAB Skonto |
| | FC Frachtgebühren |
| | IN Versicherung |
| | MAC Mindestmengenzuschlag |
| | NAA Einwegbehälter |
| | PC Verpacken |
| | RAA Rückvergütung |
| | SH Spezielle Handhabungsdienstleistungen |
| Reason | Wiederholbar 0 .. 1 |
| | Typ string |
| | Inhalt Grund des Zu-/Abschlags |

Bold = Element, *Italic* = Attribute, Grey = Group

| Element/Attribute | Annotation |
|--|---|
| CategoryTradeTax | Wiederholbar 0 .. unbounded Inhalt Detailinformationen zu Steuerangaben |
| xsd:sequence | Wiederholbar 1 .. 1 |
| TypeCode | Wiederholbar 1 .. 1 Typ token Inhalt Steuerart (Code) |
| RateApplicablePercent | Zugelassene Codes VAT Mehrwertsteuer Wiederholbar 1 .. 1 Typ decimal |
| SpecifiedTradePaymentTerms | Wiederholbar 0 .. unbounded Inhalt Detailinformationen zu Zahlungsbedingungen |
| xsd:sequence | Wiederholbar 1 .. 1 |
| Description | Wiederholbar 0 .. unbounded swissDIGIN K-05-01 Typ string Inhalt Freitext der Zahlungsbedingungen |
| DueDateDateTime | Wiederholbar 1 .. 1 swissDIGIN K-05-03 Inhalt Fälligkeitsdatum |
| xsd:choice | Wiederholbar 1 .. 1 |
| DateTimeString | Wiederholbar 1 .. 1 Typ dateTime |
| format | |
| SpecifiedTradeSettlementHeaderMonetarySummation | Zugelassene Codes 102 JJJMMTT Wiederholbar 1 .. 1 |
| xsd:sequence | Inhalt Detailinformationen zu Belegsummen Wiederholbar 1 .. 1 |
| LineTotalAmount | Wiederholbar 1 .. 1 swissDIGIN F-02-01 Typ decimal Inhalt Gesamtbetrag der Positionen |
| ChargeTotalAmount | Wiederholbar 0 .. unbounded Typ decimal Inhalt Gesamtbetrag der Zuschläge |
| AllowanceTotalAmount | Wiederholbar 0 .. unbounded Typ decimal Inhalt Gesamtbetrag der Abschläge |
| TaxBasisTotalAmount | Wiederholbar 1 .. 1 Typ decimal Inhalt Rechnungssumme ohne Umsatzsteuer |
| TaxTotalAmount | Wiederholbar 1 .. 1 @currencyID muss angegeben werden, um zwischen BT-110 und BT-111 unterscheiden zu können @currencyID muss angegeben werden, um zwischen BT-110 und BT-111 unterscheiden zu können swissDIGIN F-02-02.1 Typ decimal Inhalt Steuergesamtbetrag |
| currencyID | Inhalt Währung Zugelassene Codes ISO 4217 3A Alle Codes dieser Codeliste sind gültig |
| RoundingAmount | Wiederholbar 0 .. unbounded Typ decimal Inhalt Rundungsbetrag swissDIGIN F-02-03 |

Bold = Element, Italic = Attribute, Grey = Group



| Element/Attribute | Annotation |
|--|---|
| GrandTotalAmount | Wiederholbar 1 .. 1 swissDIGIN F-02-02 Typ decimal Inhalt Bruttosumme |
| TotalPrepaidAmount | Wiederholbar 0 .. unbounded swissDIGIN F-02-04 Typ decimal Inhalt Vorauszahlungsbetrag |
| DuePayableAmount | Wiederholbar 0 .. unbounded swissDIGIN F-02-05 Typ decimal Inhalt Zu zahlender Betrag |
| InvoiceReferencedDocument | Wiederholbar 0 .. 1 |
| <i>xsd:sequence</i> | Wiederholbar 1 .. 1 |
| IssuerAssignedID | Wiederholbar 0 .. 1 swissDIGIN K-01-07 Typ token |
| ReceivableSpecifiedTradeAccountingAccount | Wiederholbar 0 .. unbounded Inhalt Kostenzuordnungsinformationen |
| <i>xsd:sequence</i> | Wiederholbar 1 .. 1 |
| ID | Wiederholbar 1 .. 1 swissDIGIN K-06-01 Typ token |

Bold = Element, Italic = Attribute, Grey = Group

Components

rsm2:CrossIndustryInvoice Element

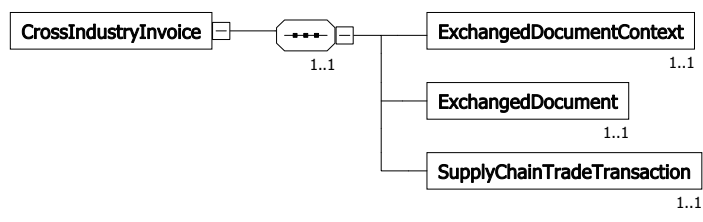

Remark Eine ZUGFeRD-Rechnung muss unabhängig vom Belegbild eine vollständige, eigenständige Rechnung abbilden. Sie soll den gleichen fachlichen Inhalt widerspiegeln, wie das Belegbild.

Name Rechnung
Type rsm2:CrossIndustryInvoiceType

| Elements | | |
|------------------------------------|---------------|---|
| ExchangedDocumentContext | Usage Type | M ram2:ExchangedDocumentContextType |
| ExchangedDocument | Usage Type | M ram2:ExchangedDocumentType |
| SupplyChainTradeTransaction | Usage Type | M ram2:SupplyChainTradeTransactionType |

qdt2:AllowanceChargeReasonCodeContentType SimpleType

Type xsd:token
Whitespace collapse

qdt2:AllowanceChargeReasonCodeType ComplexType



Type qdt:AllowanceChargeReasonCodeContentType
Whitespace collapse

qdt2:CountryIDContentType SimpleType

Type xsd:token
Whitespace collapse

qdt2:CountryIDType ComplexType



Type qdt:CountryIDContentType
Whitespace collapse

qdt2:CurrencyCodeContentType SimpleType

Type xsd:token
Whitespace collapse

| qdt2:CurrencyCodeType | | ComplexType |
|---|-----------------------------|-------------|
| <div style="border: 1px solid black; padding: 2px; display: inline-block;">CurrencyCodeType</div> | | |
| Type | qdt:CurrencyCodeContentType | |
| Whitespace | collapse | |

| qdt2:DocumentCodeContentType | | SimpleType |
|------------------------------|-----------|------------|
| Type | xsd:token | |
| Whitespace | collapse | |

| qdt2:DocumentCodeType | | ComplexType |
|---|-----------------------------|-------------|
| <div style="border: 1px solid black; padding: 2px; display: inline-block;">DocumentCodeType</div> | | |
| Type | qdt:DocumentCodeContentType | |
| Whitespace | collapse | |

| qdt2:TaxTypeCodeContentType | | SimpleType |
|-----------------------------|-----------|------------|
| Type | xsd:token | |
| Whitespace | collapse | |

| qdt2:TaxTypeCodeType | | ComplexType |
|--|----------------------------|-------------|
| <div style="border: 1px solid black; padding: 2px; display: inline-block;">TaxTypeCodeType</div> | | |
| Type | qdt:TaxTypeCodeContentType | |
| Whitespace | collapse | |

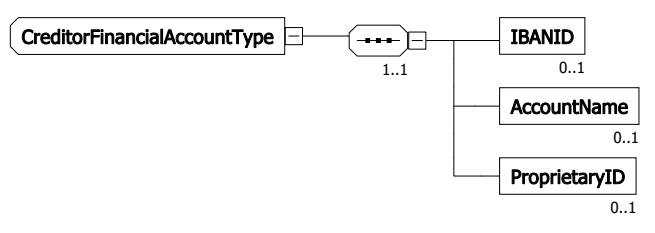
| ram2:CreditorFinancialAccountType | | ComplexType |
|---|-------|--------------|
|  | | |
| Elements | | |
| IBANID | Usage | O |
| | Type | udt:IDType |
| AccountName | Usage | O |
| | Type | udt:TextType |
| ProprietaryID | Usage | O |
| | Type | udt:IDType |

| ram2:CreditorFinancialInstitutionType | | ComplexType |
|---------------------------------------|--|-------------|
|---------------------------------------|--|-------------|



CreditorFinancialInstitutionType

| Elements | | |
|--------------|---------------|-----------------|
| BICID | Usage Type | O udt:IDType |

ram2:DocumentLineDocumentType ComplexType

| Elements | | |
|---------------------|---------------|-------------------|
| LineID | Usage Type | O udt:IDType |
| IncludedNote | Usage Type | O ram:NoteType |

ram2:ExchangedDocumentContextType ComplexType

| Elements | | |
|----------------------|---------------|------------------------|
| TestIndicator | Usage Type | O udt:IndicatorType |

ram2:ExchangedDocumentType ComplexType

| Elements | | |
|----------------------|---------------|---------------------------|
| ID | Usage Type | M udt:IDType |
| TypeCode | Usage Type | O qdt:DocumentCodeType |
| IssueDateTime | Usage Type | M udt:DateTimeType |
| IncludedNote | Usage Type | O ram:NoteType |

ram2:HeaderTradeAgreementType ComplexType

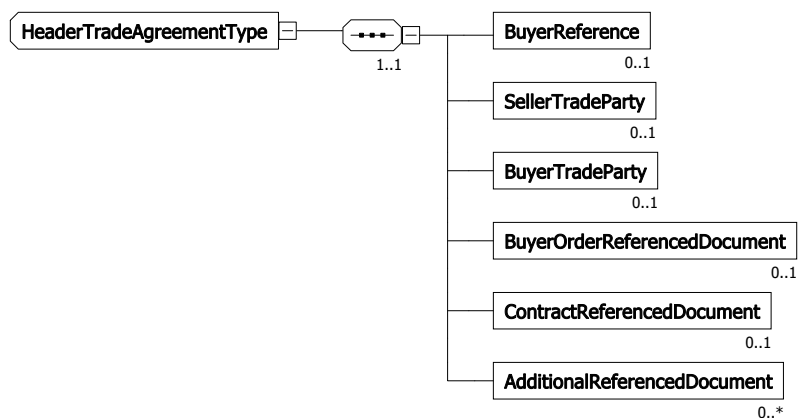

| Elements | | |
|-------------------------------------|---------------|---------------------------------|
| BuyerReference | Usage Type | O udt:TextType |
| SellerTradeParty | Usage Type | O ram:TradePartyType |
| BuyerTradeParty | Usage Type | O ram:TradePartyType |
| BuyerOrderReferencedDocument | Usage Type | O ram:ReferencedDocumentType |
| ContractReferencedDocument | Usage Type | O ram:ReferencedDocumentType |
| AdditionalReferencedDocument | Usage Type | O ram:ReferencedDocumentType |

ram2:HeaderTradeDeliveryType ComplexType

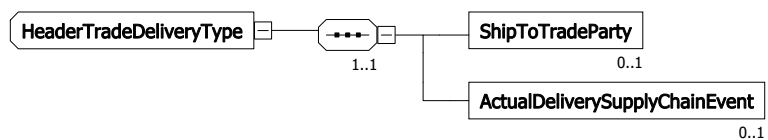

| Elements | | |
|---------------------------------------|---------------|-------------------------------|
| ShipToTradeParty | Usage Type | O ram:TradePartyType |
| ActualDeliverySupplyChainEvent | Usage Type | O ram:SupplyChainEventType |

ram2:HeaderTradeSettlementType ComplexType

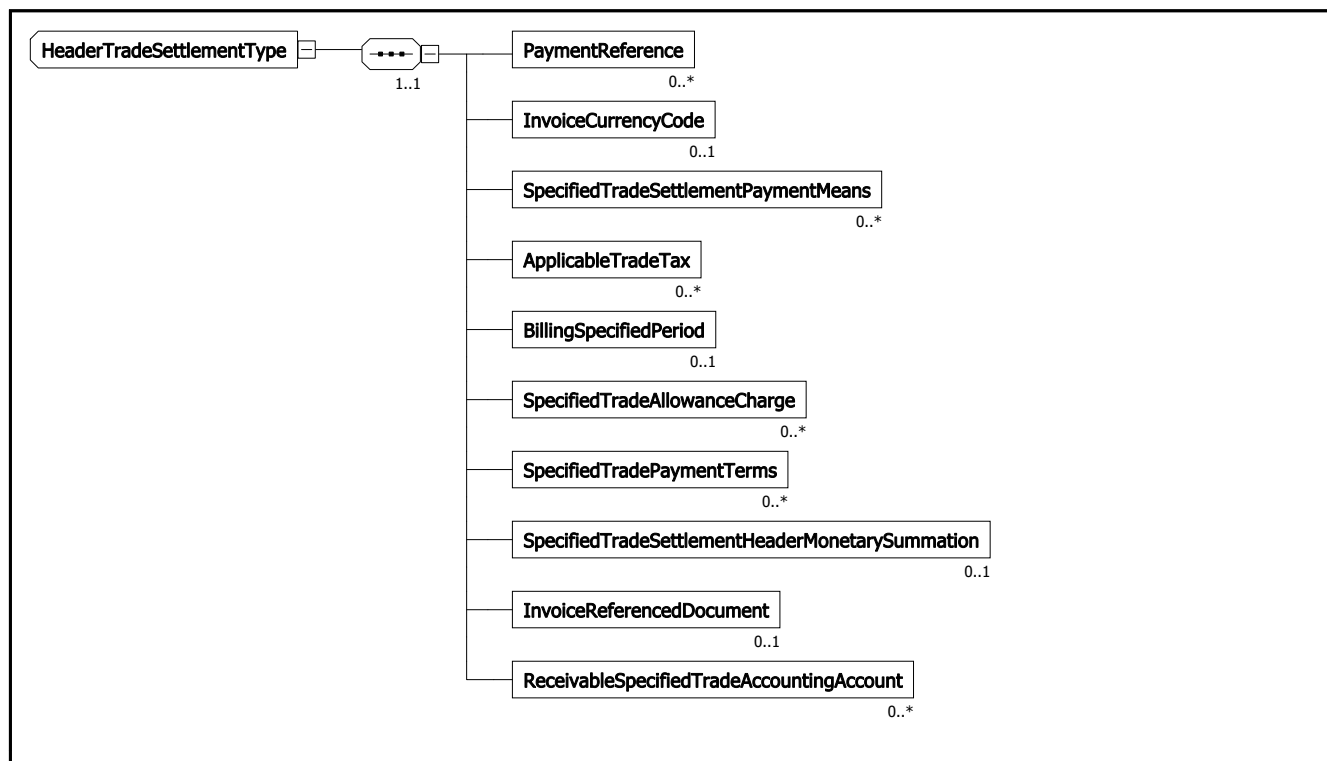

| Elements | | |
|--|---------------|---|
| PaymentReference | Usage Type | O udt:TextType |
| InvoiceCurrencyCode | Usage Type | O qdt:CurrencyCodeType |
| SpecifiedTradeSettlementPaymentMeans | Usage Type | O ram:TradeSettlementPaymentMeansType |
| ApplicableTradeTax | Usage Type | O ram:TradeTaxType |
| BillingSpecifiedPeriod | Usage Type | O ram:SpecifiedPeriodType |
| SpecifiedTradeAllowanceCharge | Usage Type | O ram:TradeAllowanceChargeType |
| SpecifiedTradePaymentTerms | Usage Type | O ram:TradePaymentTermsType |
| SpecifiedTradeSettlementHeaderMonetarySummation | Usage Type | O ram:TradeSettlementHeaderMonetarySummationType |
| InvoiceReferencedDocument | Usage Type | O ram:ReferencedDocumentType |
| ReceivableSpecifiedTradeAccountingAccount | Usage Type | O ram:TradeAccountingAccountType |

ram2:LineTradeAgreementType ComplexType

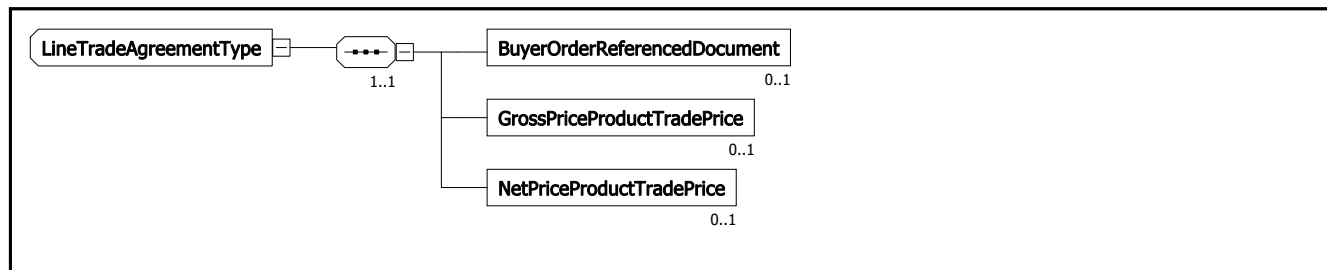

| Elements | | |
|-------------------------------------|------------|---------------------------------|
| BuyerOrderReferencedDocument | Usage Type | O ram:ReferencedDocumentType |
| GrossPriceProductTradePrice | Usage Type | O ram:TradePriceType |
| NetPriceProductTradePrice | Usage Type | O ram:TradePriceType |

ram2:LineTradeDeliveryType ComplexType

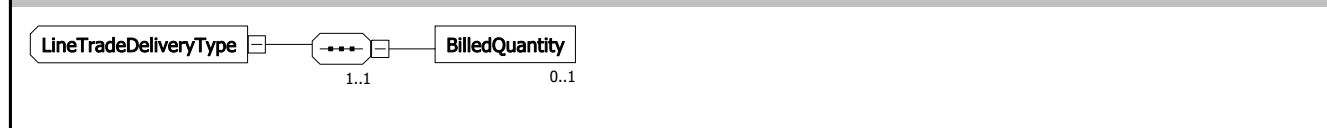

| Elements | | |
|-----------------------|------------|-----------------------|
| BilledQuantity | Usage Type | O udt:QuantityType |

ram2:LineTradeSettlementType ComplexType

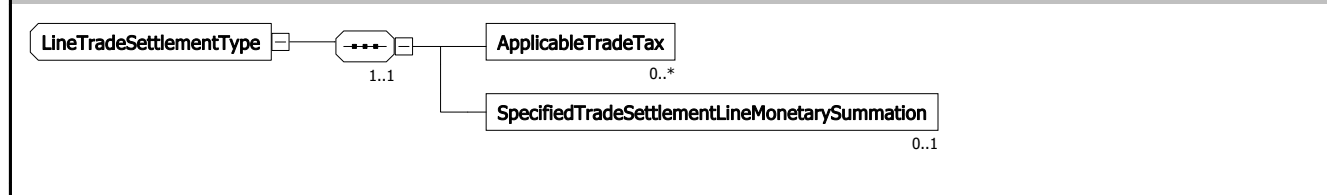

| Elements | | |
|--|------------|---|
| ApplicableTradeTax | Usage Type | O ram:TradeTaxType |
| SpecifiedTradeSettlementLineMonetarySummation | Usage Type | O ram:TradeSettlementLineMonetarySummationType |

ram2:NoteType ComplexType

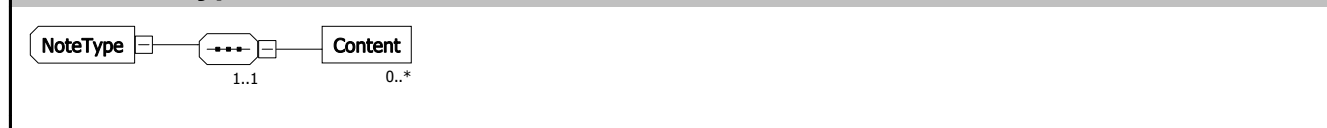

| Elements | | |
|----------------|------------|-------------------|
| Content | Usage Type | O udt:TextType |

ram2:ProductClassificationType ComplexType

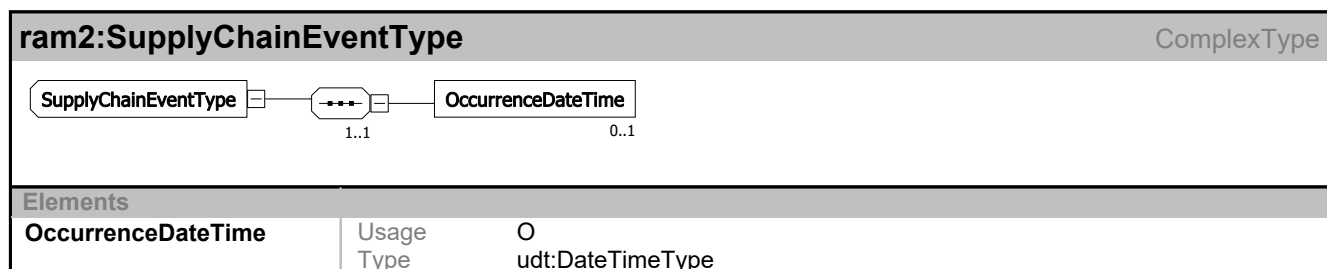
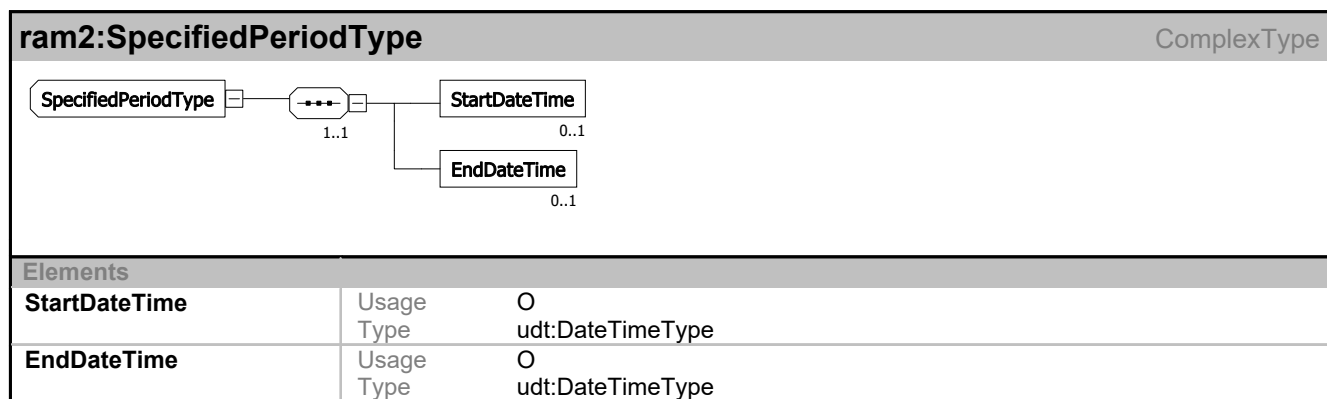
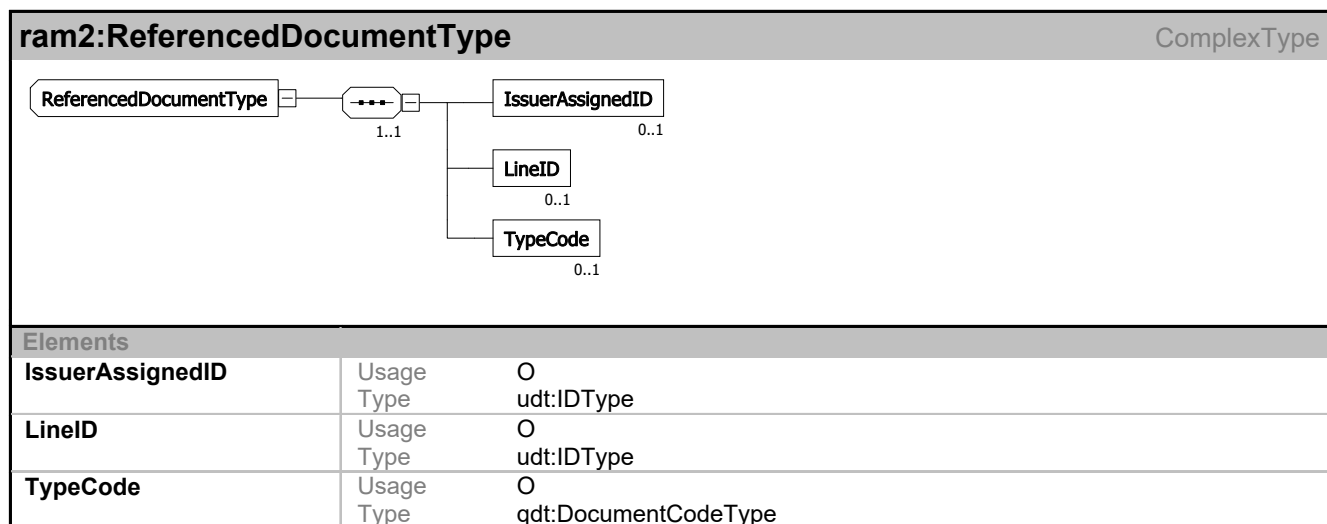
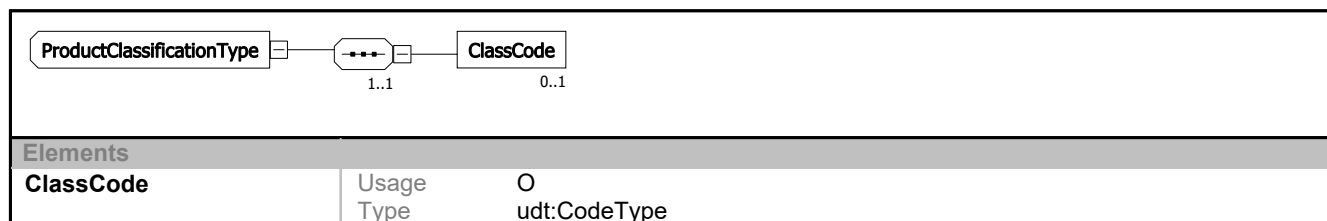

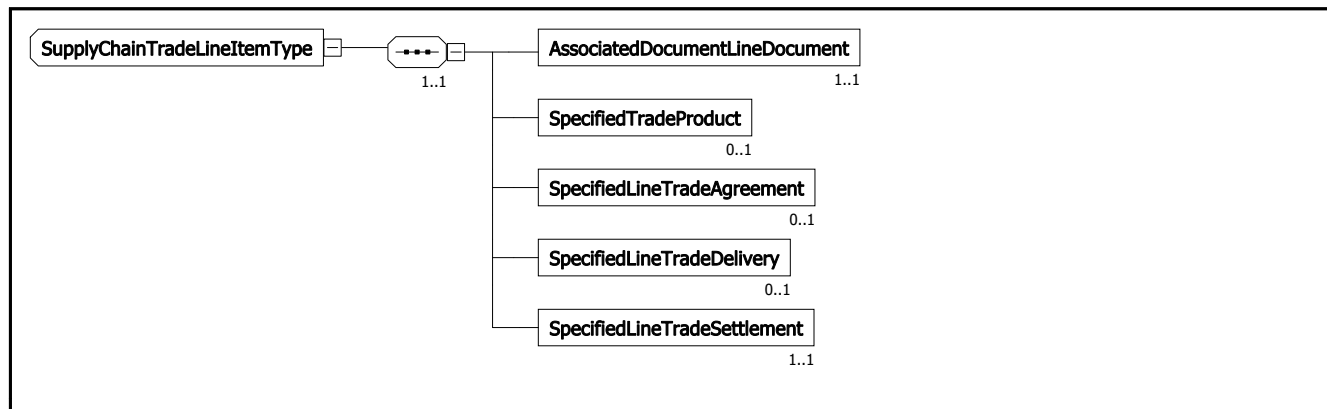

| Elements | | |
|---------------------------------------|---------------|-----------------------------------|
| AssociatedDocumentLineDocument | Usage Type | M ram:DocumentLineDocumentType |
| SpecifiedTradeProduct | Usage Type | O ram:TradeProductType |
| SpecifiedLineTradeAgreement | Usage Type | O ram:LineTradeAgreementType |
| SpecifiedLineTradeDelivery | Usage Type | O ram:LineTradeDeliveryType |
| SpecifiedLineTradeSettlement | Usage Type | M ram:LineTradeSettlementType |

ram2:SupplyChainTradeTransactionType ComplexType

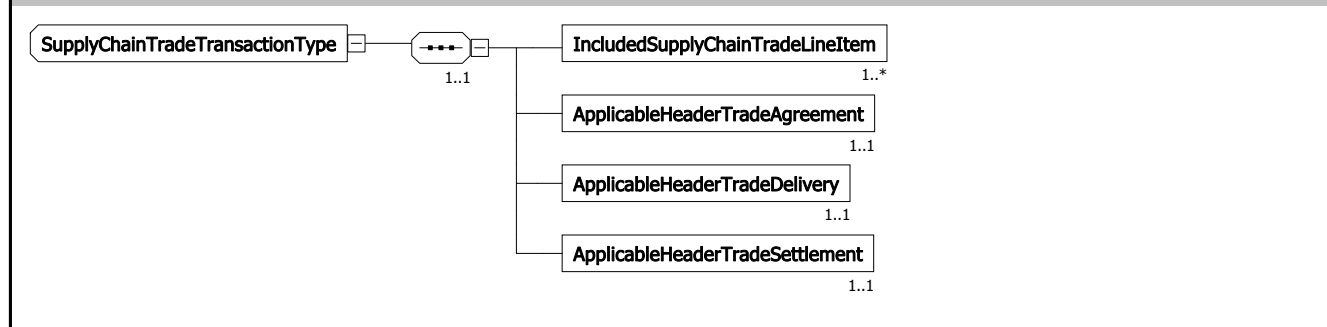

| Elements | | |
|---|---------------|---------------------------------------|
| IncludedSupplyChainTradeLineItem | Usage Type | M ram:SupplyChainTradeLineItemType |
| ApplicableHeaderTradeAgreement | Usage Type | M ram:HeaderTradeAgreementType |
| ApplicableHeaderTradeDelivery | Usage Type | M ram:HeaderTradeDeliveryType |
| ApplicableHeaderTradeSettlement | Usage Type | M ram:HeaderTradeSettlementType |

ram2:TaxRegistrationType ComplexType



| Elements | | |
|-----------|---------------|-----------------|
| ID | Usage Type | O udt:IDType |

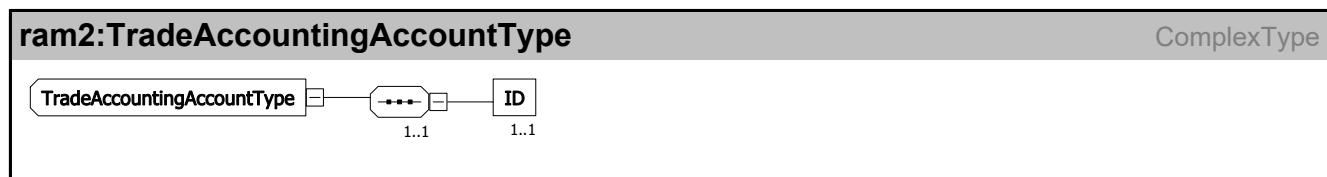

| Elements | | |
|-----------|---------------|-----------------|
| ID | Usage Type | M udt:IDType |

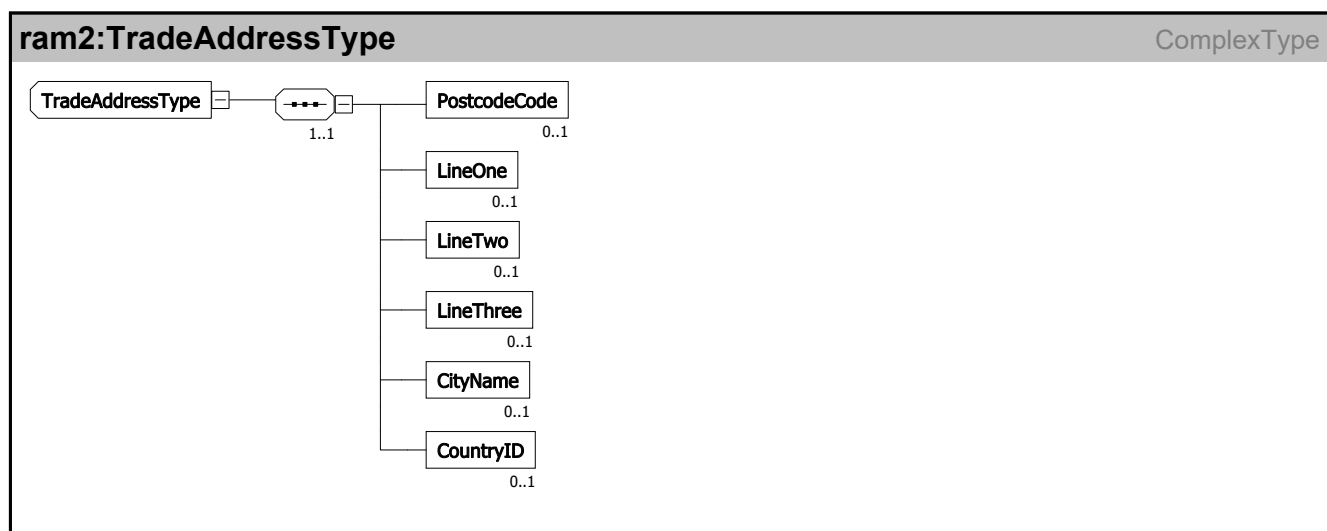

| Elements | | |
|---------------------|---------------|------------------------|
| PostcodeCode | Usage Type | O udt:CodeType |
| LineOne | Usage Type | O udt:TextType |
| LineTwo | Usage Type | O udt:TextType |
| LineThree | Usage Type | O udt:TextType |
| CityName | Usage Type | O udt:TextType |
| CountryID | Usage Type | O qdt:CountryIDType |



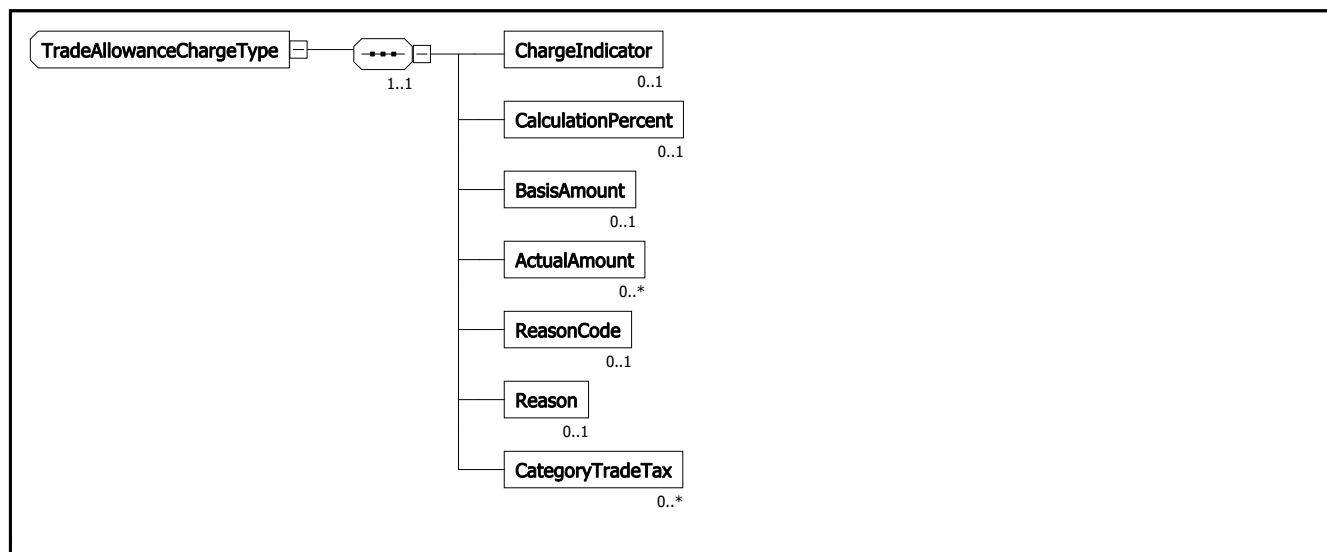

| Elements | | |
|---------------------------|---------------|--|
| ChargeIndicator | Usage Type | O udt:IndicatorType |
| CalculationPercent | Usage Type | O udt:PercentType |
| BasisAmount | Usage Type | O udt:AmountType |
| ActualAmount | Usage Type | O udt:AmountType |
| ReasonCode | Usage Type | O qdt:AllowanceChargeReasonCodeType |
| Reason | Usage Type | O udt:TextType |
| CategoryTradeTax | Usage Type | O ram:TradeTaxType |

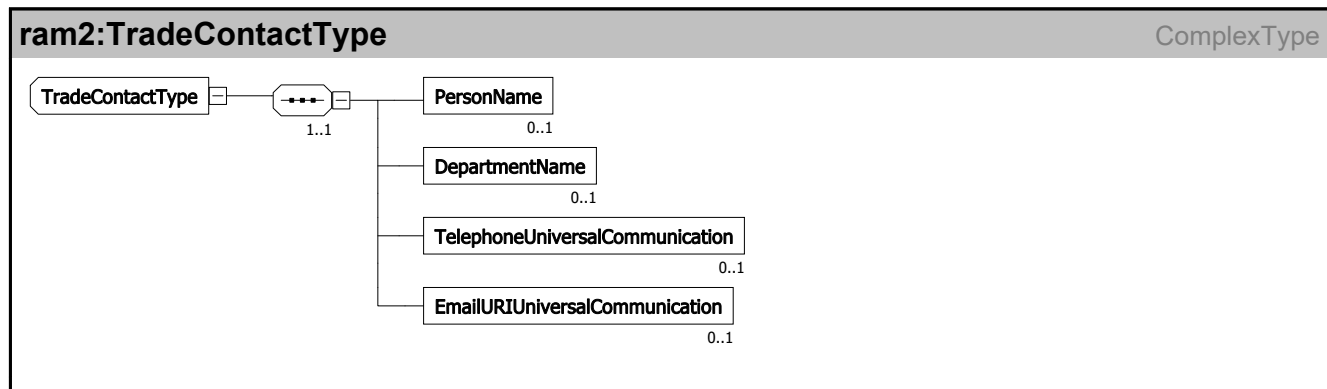

| Elements | | |
|---|---------------|-------------------------------------|
| PersonName | Usage Type | O udt:TextType |
| DepartmentName | Usage Type | O udt:TextType |
| TelephoneUniversalComm unication | Usage Type | O ram:UniversalCommunicationType |



| Elements | | |
|---------------------------------------|---------------|-------------------------------------|
| EmailURIUniversalCommunication | Usage Type | O ram:UniversalCommunicationType |

ram2:TradePartyType ComplexType

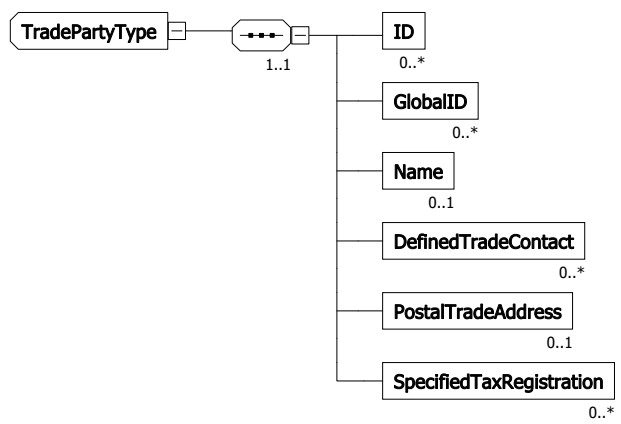

| Elements | | |
|---------------------------------|---------------|------------------------------|
| ID | Usage Type | O udt:IDType |
| GlobalID | Usage Type | O udt:IDType |
| Name | Usage Type | O udt:TextType |
| DefinedTradeContact | Usage Type | O ram:TradeContactType |
| PostalTradeAddress | Usage Type | O ram:TradeAddressType |
| SpecifiedTaxRegistration | Usage Type | O ram:TaxRegistrationType |

ram2:TradePaymentTermsType ComplexType

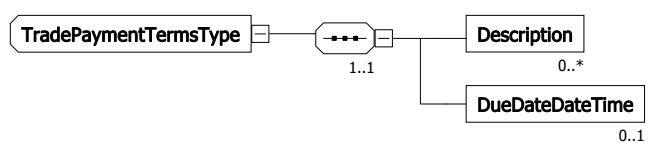

| Elements | | |
|------------------------|---------------|-----------------------|
| Description | Usage Type | O udt:TextType |
| DueDateDateTime | Usage Type | O udt:DateTimeType |

ram2:TradePriceType ComplexType

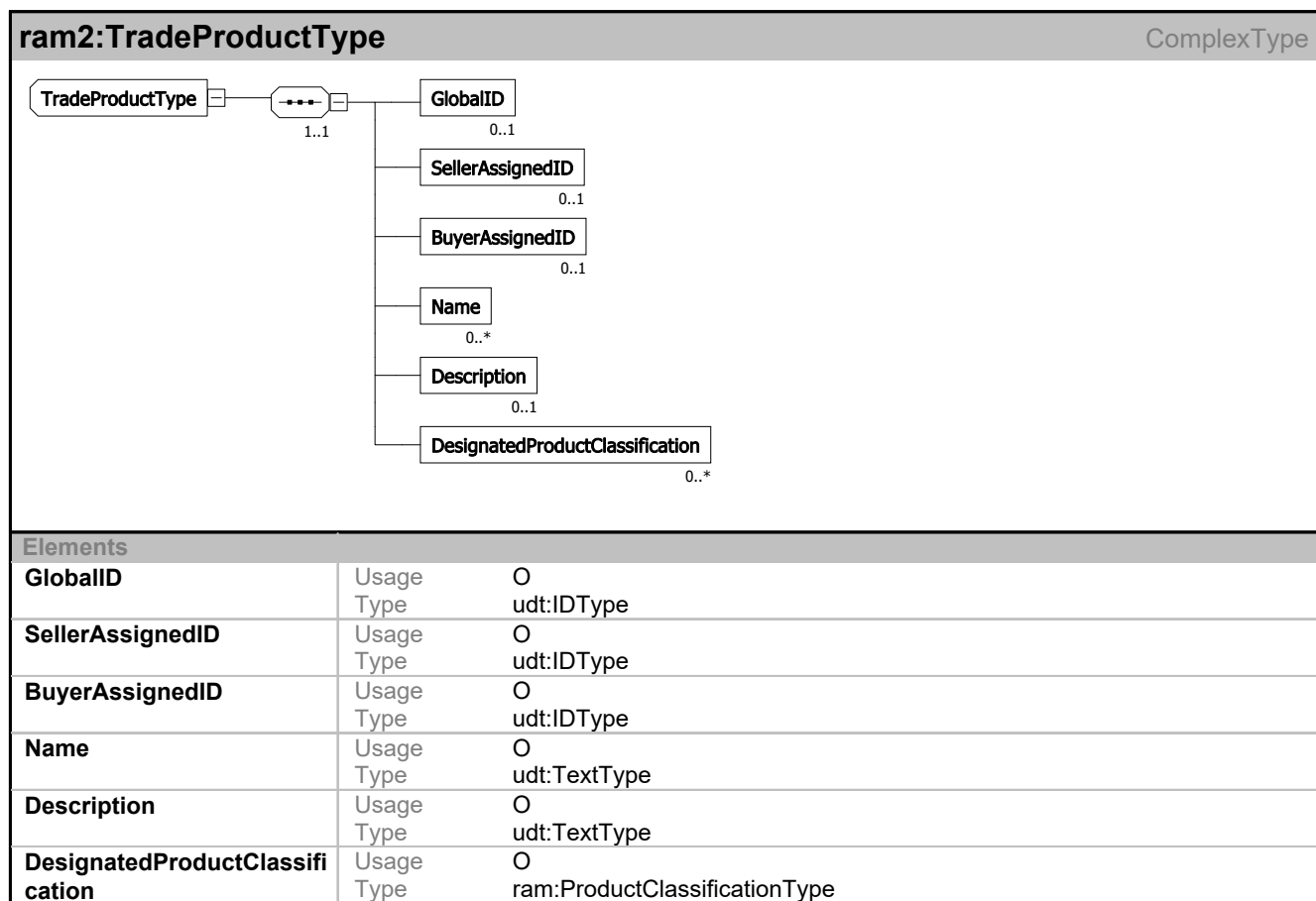
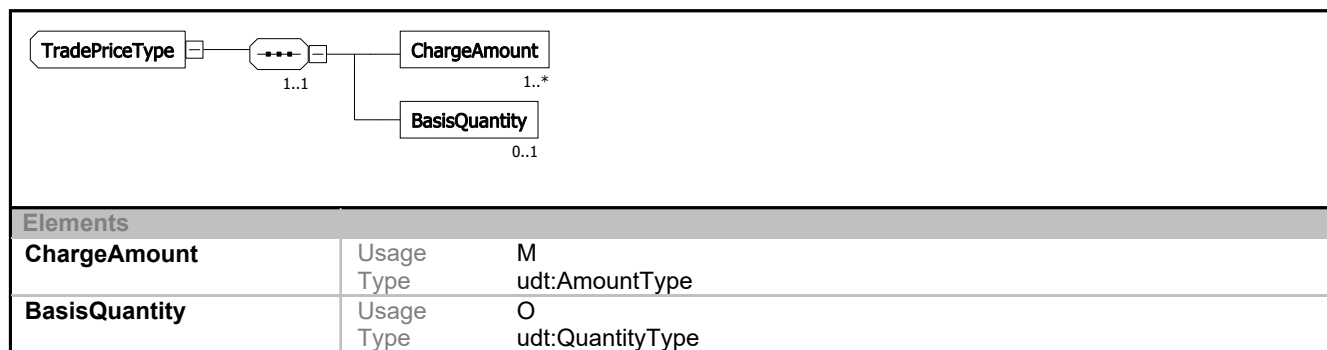

ram2:TradeSettlementHeaderMonetarySummationType ComplexType

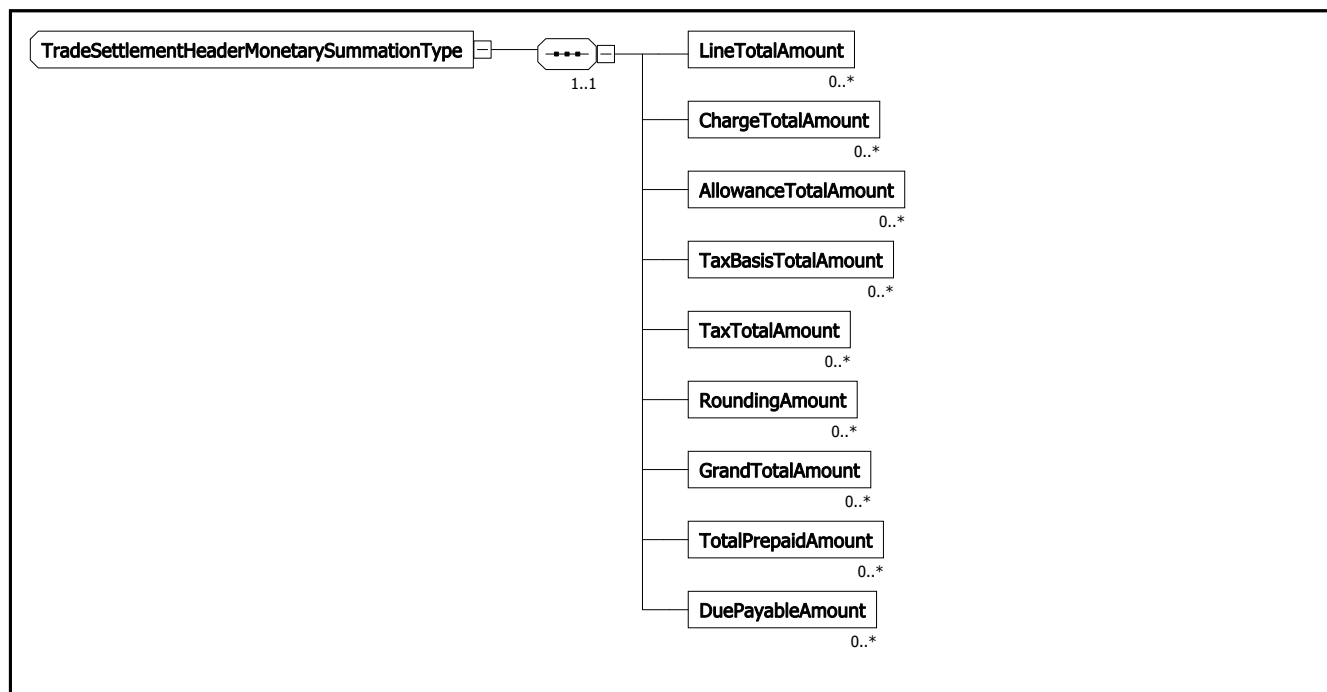

| Elements | | |
|-----------------------------|---------------|---------------------|
| LineTotalAmount | Usage Type | O udt:AmountType |
| ChargeTotalAmount | Usage Type | O udt:AmountType |
| AllowanceTotalAmount | Usage Type | O udt:AmountType |
| TaxBasisTotalAmount | Usage Type | O udt:AmountType |
| TaxTotalAmount | Usage Type | O udt:AmountType |
| RoundingAmount | Usage Type | O udt:AmountType |
| GrandTotalAmount | Usage Type | O udt:AmountType |
| TotalPrepaidAmount | Usage Type | O udt:AmountType |
| DuePayableAmount | Usage Type | O udt:AmountType |

ram2:TradeSettlementLineMonetarySummationType ComplexType

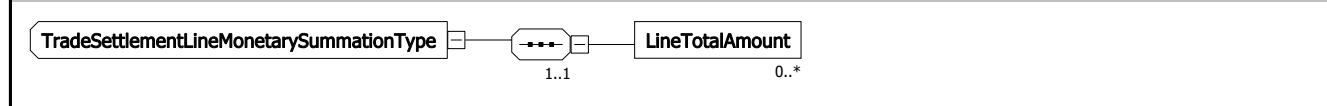

| Elements | | |
|------------------------|---------------|---------------------|
| LineTotalAmount | Usage Type | O udt:AmountType |

ram2:TradeSettlementPaymentMeansType ComplexType

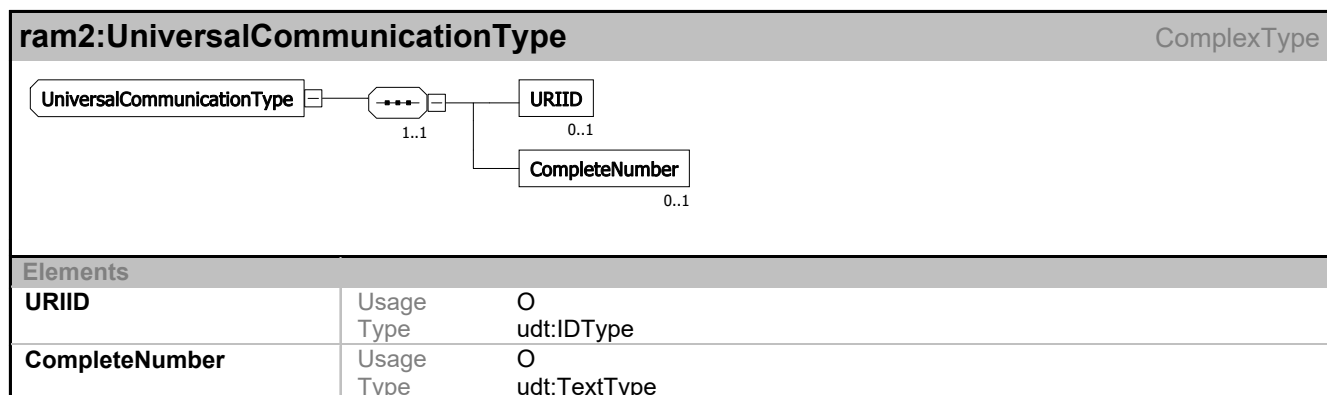
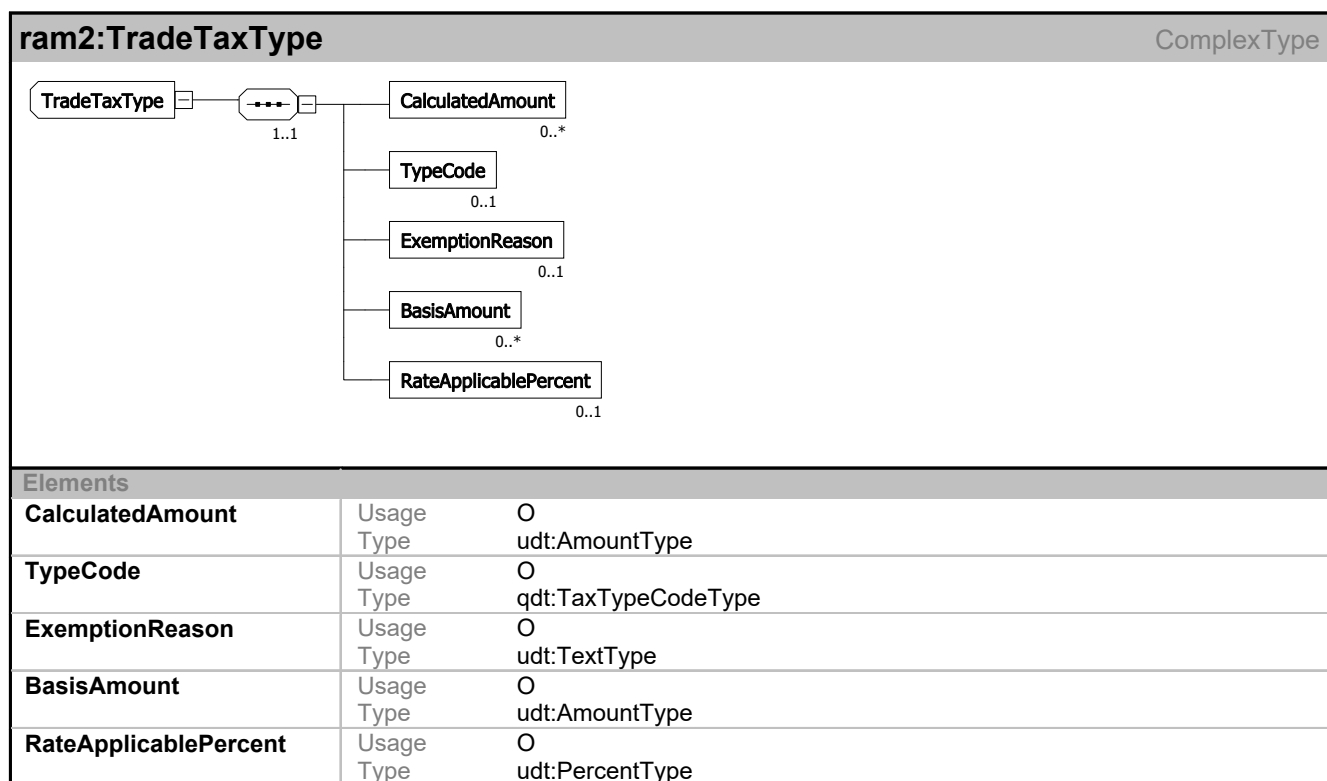
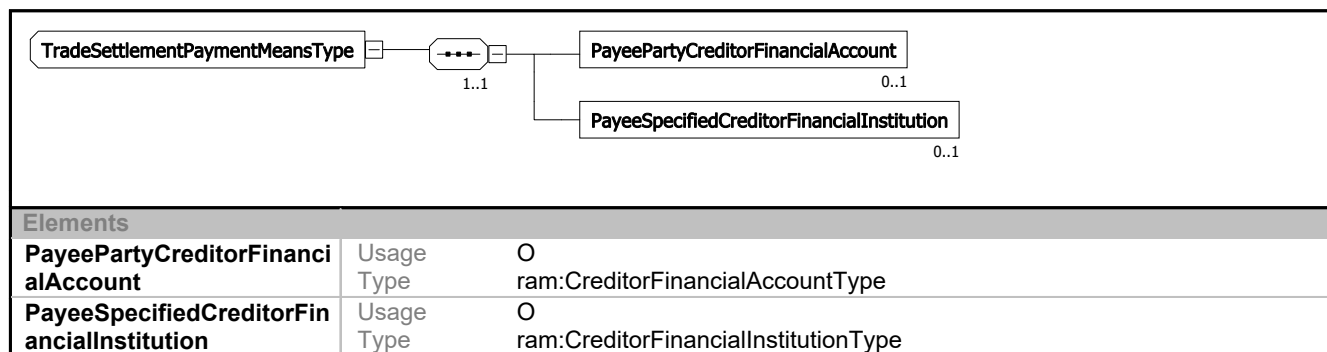

rsm2:CrossIndustryInvoiceType ComplexType

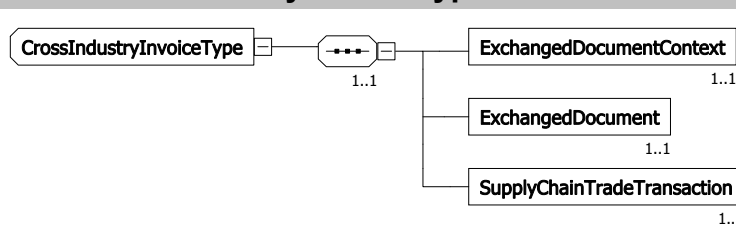

| Elements | | |
|------------------------------------|---------------|---|
| ExchangedDocumentContext | Usage Type | M ram2:ExchangedDocumentContextType |
| ExchangedDocument | Usage Type | M ram2:ExchangedDocumentType |
| SupplyChainTradeTransaction | Usage Type | M ram2:SupplyChainTradeTransactionType |

udt2:AmountType ComplexType

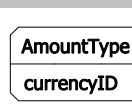

Type xsd:decimal

| Attributes | | |
|-------------------|---------------|----------------|
| currencyID | Usage Type | O xsd:token |

udt2:CodeType ComplexType



Type xsd:token

Whitespace collapse

| Attributes | | |
|---------------|---------------|----------------|
| listID | Usage Type | O xsd:token |

udt2:DateTimeType ComplexType

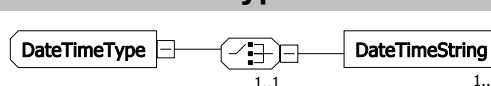

| Elements | | |
|-----------------------|---------------|-----------------------------|
| DateTimeString | Usage Type | M extension (xsd:string) |

udt2:IDType ComplexType



| | | |
|--|-----------|-----------|
| <div style="border: 1px solid black; padding: 2px; display: inline-block;">IDType</div> <div style="border: 1px solid black; padding: 2px; display: inline-block;">schemeID</div> | | |
| Type | xsd:token | |
| Whitespace | collapse | |
| Attributes | | |
| schemeID | Usage | O |
| | Type | xsd:token |

| | | |
|---|-------|-------------|
| udt2:IndicatorType | | ComplexType |
| <pre> graph LR A[IndicatorType] --- B[Indicator] style B stroke-dasharray: 5 5 A --- C[1..1] B --- D[1..1] </pre> | | |
| Elements | | |
| Indicator | Usage | M |
| | Type | xsd:boolean |

| | | |
|--|-------------|-------------|
| udt2:PercentType | | ComplexType |
| <div style="border: 1px solid black; padding: 2px; display: inline-block;">PercentType</div> | | |
| Type | xsd:decimal | |

| | | |
|--|-------------|-------------|
| udt2:QuantityType | | ComplexType |
| <div style="border: 1px solid black; padding: 2px; display: inline-block;">QuantityType</div> <div style="border: 1px solid black; padding: 2px; display: inline-block;">unitCode</div> | | |
| Type | xsd:decimal | |
| Attributes | | |
| unitCode | Usage | O |
| | Type | xsd:token |

| | | |
|---|------------|-------------|
| udt2:TextType | | ComplexType |
| <div style="border: 1px solid black; padding: 2px; display: inline-block;">TextType</div> | | |
| Type | xsd:string | |

| | |
|-------------------|------------|
| xs:boolean | SimpleType |
|-------------------|------------|

| | |
|-------------------|------------|
| xs:decimal | SimpleType |
|-------------------|------------|

| | | |
|----------------------------|-----------|------------|
| xs:normalizedString | | SimpleType |
| Type | xs:string | |
| Whitespace | replace | |



| | |
|------------------|------------|
| xs:string | SimpleType |
|------------------|------------|

| | |
|-----------------|------------|
| xs:token | SimpleType |
|-----------------|------------|

| | |
|------------|---------------------|
| Type | xs:normalizedString |
| Whitespace | collapse |

swissDIGIN Felder

| Nr. | Pfad |
|-----------|---|
| F-01-01 | CrossIndustryInvoice/SupplyChainTradeTransaction/ApplicableHeaderTradeSettlement/ ApplicableTradeTax/RateApplicablePercent |
| F-01-02 | CrossIndustryInvoice/SupplyChainTradeTransaction/ApplicableHeaderTradeSettlement/ ApplicableTradeTax/BasisAmount |
| F-01-03 | CrossIndustryInvoice/SupplyChainTradeTransaction/ApplicableHeaderTradeSettlement/ ApplicableTradeTax/CalculatedAmount |
| F-01-04 | CrossIndustryInvoice/SupplyChainTradeTransaction/ApplicableHeaderTradeSettlement/ ApplicableTradeTax/ExemptionReason |
| F-02-01 | CrossIndustryInvoice/SupplyChainTradeTransaction/ApplicableHeaderTradeSettlement/ SpecifiedTradeSettlementHeaderMonetarySummation/LineTotalAmount |
| F-02-02 | CrossIndustryInvoice/SupplyChainTradeTransaction/ApplicableHeaderTradeSettlement/ SpecifiedTradeSettlementHeaderMonetarySummation/GrandTotalAmount |
| F-02-02.1 | CrossIndustryInvoice/SupplyChainTradeTransaction/ApplicableHeaderTradeSettlement/ SpecifiedTradeSettlementHeaderMonetarySummation/TaxTotalAmount |
| F-02-03 | CrossIndustryInvoice/SupplyChainTradeTransaction/ApplicableHeaderTradeSettlement/ SpecifiedTradeSettlementHeaderMonetarySummation/RoundingAmount |
| F-02-04 | CrossIndustryInvoice/SupplyChainTradeTransaction/ApplicableHeaderTradeSettlement/ SpecifiedTradeSettlementHeaderMonetarySummation/TotalPrepaidAmount |
| F-02-05 | CrossIndustryInvoice/SupplyChainTradeTransaction/ApplicableHeaderTradeSettlement/ SpecifiedTradeSettlementHeaderMonetarySummation/DuePayableAmount |
| K-01-01 | CrossIndustryInvoice/ExchangedDocument/TypeCode |
| K-01-02 | CrossIndustryInvoice/ExchangedDocument/ID |
| K-01-03 | CrossIndustryInvoice/ExchangedDocument/IssueDateTime/DateTimeString |
| K-01-04 | CrossIndustryInvoice/SupplyChainTradeTransaction/ApplicableHeaderTradeSettlement/ InvoiceCurrencyCode |
| K-01-05 | CrossIndustryInvoice/SupplyChainTradeTransaction/ApplicableHeaderTradeAgreement/BuyerReference |
| K-01-06 | CrossIndustryInvoice/SupplyChainTradeTransaction/ApplicableHeaderTradeAgreement/ BuyerOrderReferencedDocument |
| K-01-06 | CrossIndustryInvoice/SupplyChainTradeTransaction/ApplicableHeaderTradeAgreement/ ContractReferencedDocument/IssuerAssignedID |
| K-01-07 | CrossIndustryInvoice/SupplyChainTradeTransaction/ApplicableHeaderTradeAgreement/ AdditionalReferencedDocument/IssuerAssignedID |
| K-01-07 | CrossIndustryInvoice/SupplyChainTradeTransaction/ApplicableHeaderTradeSettlement/ InvoiceReferencedDocument/IssuerAssignedID |
| K-02-01 | CrossIndustryInvoice/SupplyChainTradeTransaction/ApplicableHeaderTradeAgreement/SellerTradeParty/ID |
| K-02-01 | CrossIndustryInvoice/SupplyChainTradeTransaction/ApplicableHeaderTradeAgreement/SellerTradeParty/ GlobalID |
| K-02-02 | CrossIndustryInvoice/SupplyChainTradeTransaction/ApplicableHeaderTradeAgreement/SellerTradeParty/ SpecifiedTaxRegistration/ID |
| K-02-02.1 | CrossIndustryInvoice/SupplyChainTradeTransaction/ApplicableHeaderTradeSettlement/ ApplicableTradeTax/TypeCode |
| K-02-03-a | CrossIndustryInvoice/SupplyChainTradeTransaction/ApplicableHeaderTradeAgreement/SellerTradeParty/ Name |
| K-02-03-b | CrossIndustryInvoice/SupplyChainTradeTransaction/ApplicableHeaderTradeAgreement/SellerTradeParty/ PostalTradeAddress/LineOne |
| K-02-03-b | CrossIndustryInvoice/SupplyChainTradeTransaction/ApplicableHeaderTradeAgreement/SellerTradeParty/ PostalTradeAddress/LineTwo |
| K-02-03-b | CrossIndustryInvoice/SupplyChainTradeTransaction/ApplicableHeaderTradeAgreement/SellerTradeParty/ PostalTradeAddress/LineThree |
| K-02-03-c | CrossIndustryInvoice/SupplyChainTradeTransaction/ApplicableHeaderTradeAgreement/SellerTradeParty/ PostalTradeAddress/CityName |
| K-02-03-d | CrossIndustryInvoice/SupplyChainTradeTransaction/ApplicableHeaderTradeAgreement/SellerTradeParty/ PostalTradeAddress/PostcodeCode |
| K-02-03-e | CrossIndustryInvoice/SupplyChainTradeTransaction/ApplicableHeaderTradeAgreement/SellerTradeParty/ PostalTradeAddress/CountryID |
| K-02-04 | CrossIndustryInvoice/SupplyChainTradeTransaction/ApplicableHeaderTradeAgreement/SellerTradeParty/ DefinedTradeContact/DepartmentName |
| K-02-05 | CrossIndustryInvoice/SupplyChainTradeTransaction/ApplicableHeaderTradeAgreement/SellerTradeParty/ DefinedTradeContact/PersonName |
| K-02-05 | CrossIndustryInvoice/SupplyChainTradeTransaction/ApplicableHeaderTradeAgreement/SellerTradeParty/ DefinedTradeContact/TelephoneUniversalCommunication/CompleteNumber |
| K-02-05 | CrossIndustryInvoice/SupplyChainTradeTransaction/ApplicableHeaderTradeAgreement/SellerTradeParty/ DefinedTradeContact/EmailURIUniversalCommunication/URIID |
| K-03-01 | CrossIndustryInvoice/SupplyChainTradeTransaction/ApplicableHeaderTradeAgreement/BuyerTradeParty/ID |
| K-03-01 | CrossIndustryInvoice/SupplyChainTradeTransaction/ApplicableHeaderTradeAgreement/BuyerTradeParty/ GlobalID |
| K-03-02 | CrossIndustryInvoice/SupplyChainTradeTransaction/ApplicableHeaderTradeAgreement/BuyerTradeParty/ |

swissDIGIN Felder

| Nr. | Pfad |
|------------|--|
| K-03-03-a | SpecifiedTaxRegistration/ID CrossIndustryInvoice/SupplyChainTradeTransaction/ApplicableHeaderTradeAgreement/BuyerTradeParty/Name |
| K-03-03-b | CrossIndustryInvoice/SupplyChainTradeTransaction/ApplicableHeaderTradeAgreement/BuyerTradeParty/PostalTradeAddress/LineOne |
| K-03-03-b | CrossIndustryInvoice/SupplyChainTradeTransaction/ApplicableHeaderTradeAgreement/BuyerTradeParty/PostalTradeAddress/LineTwo |
| K-03-03-b | CrossIndustryInvoice/SupplyChainTradeTransaction/ApplicableHeaderTradeAgreement/BuyerTradeParty/PostalTradeAddress/LineThree |
| K-03-03-c | CrossIndustryInvoice/SupplyChainTradeTransaction/ApplicableHeaderTradeAgreement/BuyerTradeParty/PostalTradeAddress/CityName |
| K-03-03-d | CrossIndustryInvoice/SupplyChainTradeTransaction/ApplicableHeaderTradeAgreement/BuyerTradeParty/PostalTradeAddress/PostcodeCode |
| K-03-03-e | CrossIndustryInvoice/SupplyChainTradeTransaction/ApplicableHeaderTradeAgreement/BuyerTradeParty/PostalTradeAddress/CountryID |
| K-03-05 | CrossIndustryInvoice/SupplyChainTradeTransaction/ApplicableHeaderTradeAgreement/BuyerTradeParty/DefinedTradeContact/DepartmentName |
| K-03-06 | CrossIndustryInvoice/SupplyChainTradeTransaction/ApplicableHeaderTradeAgreement/BuyerTradeParty/DefinedTradeContact/PersonName |
| K-04-01-a | CrossIndustryInvoice/SupplyChainTradeTransaction/ApplicableHeaderTradeDelivery/ActualDeliverySupplyChainEvent/OccurrenceDateTime/DateTimeString |
| K-04-01-a | CrossIndustryInvoice/SupplyChainTradeTransaction/ApplicableHeaderTradeSettlement/BillingSpecifiedPeriod/EndDateTime |
| K-04-01-b | CrossIndustryInvoice/SupplyChainTradeTransaction/ApplicableHeaderTradeSettlement/BillingSpecifiedPeriod/StartDateTime |
| K-04-02-a | CrossIndustryInvoice/SupplyChainTradeTransaction/ApplicableHeaderTradeDelivery/ShipToTradeParty/Name |
| K-04-02-a1 | CrossIndustryInvoice/SupplyChainTradeTransaction/ApplicableHeaderTradeDelivery/ShipToTradeParty/ID |
| K-04-02-a1 | CrossIndustryInvoice/SupplyChainTradeTransaction/ApplicableHeaderTradeDelivery/ShipToTradeParty/GlobalID |
| K-04-02-b | CrossIndustryInvoice/SupplyChainTradeTransaction/ApplicableHeaderTradeDelivery/ShipToTradeParty/PostalTradeAddress/LineOne |
| K-04-02-b | CrossIndustryInvoice/SupplyChainTradeTransaction/ApplicableHeaderTradeDelivery/ShipToTradeParty/PostalTradeAddress/LineTwo |
| K-04-02-b | CrossIndustryInvoice/SupplyChainTradeTransaction/ApplicableHeaderTradeDelivery/ShipToTradeParty/PostalTradeAddress/LineThree |
| K-04-02-c | CrossIndustryInvoice/SupplyChainTradeTransaction/ApplicableHeaderTradeDelivery/ShipToTradeParty/PostalTradeAddress/CityName |
| K-04-02-d | CrossIndustryInvoice/SupplyChainTradeTransaction/ApplicableHeaderTradeDelivery/ShipToTradeParty/PostalTradeAddress/PostcodeCode |
| K-04-02-e | CrossIndustryInvoice/SupplyChainTradeTransaction/ApplicableHeaderTradeDelivery/ShipToTradeParty/PostalTradeAddress/CountryID |
| K-04-04 | CrossIndustryInvoice/SupplyChainTradeTransaction/ApplicableHeaderTradeAgreement/AdditionalReferencedDocument/IssuerAssignedID |
| K-05-01 | CrossIndustryInvoice/SupplyChainTradeTransaction/ApplicableHeaderTradeSettlement/SpecifiedTradePaymentTerms/Description |
| K-05-03 | CrossIndustryInvoice/SupplyChainTradeTransaction/ApplicableHeaderTradeSettlement/SpecifiedTradePaymentTerms/DueDateTime |
| K-05-05 | CrossIndustryInvoice/SupplyChainTradeTransaction/ApplicableHeaderTradeSettlement/PaymentReference |
| K-05-06 | CrossIndustryInvoice/SupplyChainTradeTransaction/ApplicableHeaderTradeSettlement/SpecifiedTradeSettlementPaymentMeans/PayeePartyCreditorFinancialAccount/ProprietaryID |
| K-05-07-a | CrossIndustryInvoice/SupplyChainTradeTransaction/ApplicableHeaderTradeSettlement/SpecifiedTradeSettlementPaymentMeans/PayeeSpecifiedCreditorFinancialInstitution/BICID |
| K-05-08-a | CrossIndustryInvoice/SupplyChainTradeTransaction/ApplicableHeaderTradeSettlement/SpecifiedTradeSettlementPaymentMeans/PayeePartyCreditorFinancialAccount/IBANID |
| K-05-08-b | CrossIndustryInvoice/SupplyChainTradeTransaction/ApplicableHeaderTradeSettlement/SpecifiedTradeSettlementPaymentMeans/PayeePartyCreditorFinancialAccount/AccountName |
| K-06-01 | CrossIndustryInvoice/SupplyChainTradeTransaction/ApplicableHeaderTradeSettlement/ReceivableSpecifiedTradeAccountingAccount/ID |
| K-06-03 | CrossIndustryInvoice/ExchangedDocument/IncludedNote/Content |
| P-01-02 | CrossIndustryInvoice/SupplyChainTradeTransaction/IncludedSupplyChainTradeLineItem/SpecifiedLineTradeAgreement/BuyerOrderReferencedDocument/LineID |
| P-02-01 | CrossIndustryInvoice/SupplyChainTradeTransaction/IncludedSupplyChainTradeLineItem/SpecifiedTradeProduct/SellerAssignedID |
| P-02-02 | CrossIndustryInvoice/SupplyChainTradeTransaction/IncludedSupplyChainTradeLineItem/SpecifiedTradeProduct/BuyerAssignedID |
| P-02-03 | CrossIndustryInvoice/SupplyChainTradeTransaction/IncludedSupplyChainTradeLineItem/ |

swissDIGIN Felder

| Nr. | Pfad |
|-----------|--|
| P-02-03.1 | SpecifiedTradeProduct/GlobalID |
| P-02-04 | CrossIndustryInvoice/SupplyChainTradeTransaction/IncludedSupplyChainTradeLineItem/SpecifiedTradeProduct/DesignatedProductClassification/ClassCode |
| P-02-05 | CrossIndustryInvoice/SupplyChainTradeTransaction/IncludedSupplyChainTradeLineItem/SpecifiedTradeProduct/Description |
| P-02-06 | CrossIndustryInvoice/SupplyChainTradeTransaction/IncludedSupplyChainTradeLineItem/SpecifiedLineTradeAgreement/NetPriceProductTradePrice/BasisQuantity |
| P-02-07 | CrossIndustryInvoice/SupplyChainTradeTransaction/IncludedSupplyChainTradeLineItem/SpecifiedLineTradeAgreement/NetPriceProductTradePrice/BasisQuantity/@unitCode |
| P-04-01 | CrossIndustryInvoice/SupplyChainTradeTransaction/IncludedSupplyChainTradeLineItem/SpecifiedLineTradeDelivery/BilledQuantity |
| P-04-02 | CrossIndustryInvoice/SupplyChainTradeTransaction/IncludedSupplyChainTradeLineItem/SpecifiedLineTradeAgreement/GrossPriceProductTradePrice/ChargeAmount |
| P-04-03 | CrossIndustryInvoice/SupplyChainTradeTransaction/IncludedSupplyChainTradeLineItem/SpecifiedLineTradeSettlement/ApplicableTradeTax/RateApplicablePercent |
| P-04-04 | CrossIndustryInvoice/SupplyChainTradeTransaction/IncludedSupplyChainTradeLineItem/SpecifiedLineTradeSettlement/SpecifiedTradeSettlementLineMonetarySummation/LineTotalAmount |

GS1 Schweiz - The Global Language of Business

GS1 Switzerland ermöglicht Lösungen für effizientere Wertschöpfungsnetzwerke mit Hilfe globaler Standards. Wir unterstützen Unternehmen bei der Optimierung ihrer Waren-, Informations- und Werteflüsse und vermitteln praxisnahes Wissen. Gemeinsam mit unseren Mitgliedern erarbeiten wir Standards und Prozessempfehlungen und schaffen Nutzen für alle Beteiligten. GS1 Switzerland ist ein neutraler Verein mit Sitz in Bern und Teil der in 140 Ländern tätigen not-for-profit Organisation GS1.

GS1 Switzerland

Monbijoustrasse 68

CH-3007 Bern

T +41 58 800 70 00

www.gs1.ch



GS1 is a registered trademark of GS1 AISBL.

All contents copyright © GS1 Switzerland 2018

Elektronische Hybridrechnung PDF mit XML, Anwendungsempfehlung für die Schweiz

Version 1.0, August 2018 | 76 12345 20459 8

